



RG-S2600E/P

RGOS 10.4(2)

©2010



RGOS® 10.4(2)

,
,
,

1.

Courier New

5

2.

Arial

```
[]      []  
{x|y|...}  
[x|y|...]  
//
```

3.

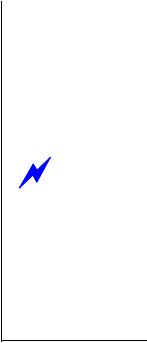

1.

2.

3.



1 CLI

1.1

1.1.1 alias

alias

no

alias *mode command-alias original-command*

no alias *mode [original-command]*

<i>mode</i>	
<i>command-alias</i>	
<i>original-command</i>	

EXEC

EXEC h p s u un help ping show
undebug undebug
no alias exec

```

Ruijie# s?
*s=show show start-chat start-terminal-service
EXEC
"sv" "show version"
Ruijie# s?
*s=show *sv="show version" show start-chat
start-terminal-service

Ruijie# s?
show start-chat start-terminal-service
"ia"
"ip address"
Ruijie(config-if)# ia ?
A.B.C.D IP address
dhcp IP Address via DHCP
Ruijie(config-if)# ip address
"ip address"

show aliases

```

```

"def-route" "ip route"
0.0.0.0 0.0.0.0 192.168.1.1"
Ruijie# configure terminal
Ruijie(config)# alias config def-route ip route 0.0.0.0 0.0.0.0
192.168.1.1
Ruijie(config)# def-route?
*def-route="ip route 0.0.0.0 0.0.0.0 192.168.1.1"
Ruijie(config)# def-route?
% Unrecognized command.
Ruijie(config)# end
Ruijie# show aliases config
globe configure mode alias:
def-route ip route 0.0.0.0 0.0.0.0 192.168.1.1

```

show aliases	

privilege

ommand-string

mand-string

CLI

0-15

CLI

privilege ?

0.0.2 294.68 -139.2 -19.1Hp

```

Ruijie(config)# enable secret level 1 0 test
Ruijie(config)# privilege exec level 1 reload
                1    CLI                reload
Ruijie> reload ?
<cr>
                reload                1                all
Ruijie(config)# privilege exec all level 1 reload
                1    CLI                reload
Ruijie> reload ?
at                reload at a specific time/date
cancel            cancel pending reload scheme
in                reload after a time interval
<cr>

```

enable secret	CLI

EXEC

```
Ruijie# show aliases exec
```

```
exec mode alias:
```

```
h             help  
p             ping  
s             show  
u             undebug  
un            undebug
```



2

2.1

2.1.1 disable

disable

disable [*privilege-level*]

	<i>privilege-level</i>	

|

|

|

/ **disable**

|

Ruijie# **disable 10**

	enable	

|

	-	-

2.1.2 enable

enable

	-	-

--	--

--	--

--	--

--	--

	-	-

--	--

	-	-

2.1.3 enable password

enable password

no

enable password [*level level*] {*password* | [0 | 7] *encrypted-password*} **no enable password**

<i>Password</i>	EXEC	
<i>Level</i>		
0 7	0	7
<i>encrypted-password</i>		

> 1 26

>

 EXEC

pw10

Ruijie(config)# **enable password** pw10

enable secret	

-	-

2.1.4 enable secret

enable secret **no**

enable secret [*level level*] {*secret* | [0 | 5] *encrypted-secret*}

no enable secret

<i>Secret</i>	EXEC
<i>Level</i>	
0 5	0 5
<i>encrypted-password</i>	

|

|

|

|

no enable service

enable service ssh-sesrver, SSH Server

Ruijie(Config # **enable service ssh-sesrver**



Telnet

configure terminal

line tty 1 16

enable

Web

no ip http authentication

Web

local

Ruijie(config)# **ip http authentication local**

enable service

┌

┌

-	-

2.1.9 ip telnet source-interface

IP Telnet ip
telnet source-interface

ip telnet source-interface *interface-name*

┌

<i>interface-name</i>	IP Telnet

┌

┌

┌

IP Telnet telnet
Telnet
no ip telnet source-interface

┌

Loopback 1 IP Telnet
Ruijie(config)# **ip telnet source-interface** *Loopback 1*

┌

telnet	Telnet

┌

┌

10.4(2)	

2.1.10 lock

EXEC

lock

lock

-	-

|

|

|

> lock

>

" Locked"

>

line

lockable

line

|

Ruijie(config-line)# lockable

Ruijie(config-line)# end

Ruijie# lock

Password: <password>

Again: <password>

Locked

Password: <password>

|

lockable	

|

|

-	-

2.1.11 lockable

lock **lock** **no** **line** **lockable**

lockable

no lockable

	-	-

|

| line

| **lock**

EXEC

```
Ruijie(config)# line console 0  
Ruijie(config-line)# lockable  
Ruijie(config-line)# end  
Ruijie# lock  
Password: <password>  
Again: <password>  
Locked  
Password: <password>
```

lock		

login

no login

	-	-

|

|

line

|

AAA
VTY console

|

VTY
Ruijie(config)# **no aaa new-model**
Ruijie(config)# **line vty 0**
Ruijie(config-line)# **password 0 normatest**
Ruijie(config-line)# **login**

|

--	--

password

line

-

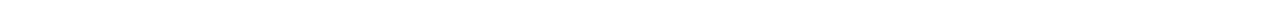

line

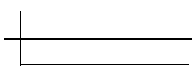

username

VTY

Ruijie(config)# **no aaa new-model**

Ruijie(config)# **username test password 0 test**

Ruijie(config)# **line vty 0**

Ruijie(config-line)# **login local**

username	

-	-

2.1.15 privilege mode

CLI

-	-

CLI

CLI

CLI

CLI

-	-

--	--

	-	-
--	---	---

2.1.16 password

line line **password** **no** line

password {*password* | [0-7] *encrypted-password*}

no password

<i>password</i>		line

service password-encryption

--	--

interface <i>interface-name</i>	Telnet
!vrf <i>vrf-name</i>	VRF

┌

┌

┌

telnet	
 /ipv6	IPV6

┌

```

1          telnet          IPV4          192.168.1.1
          vlan 1          VRF          vpn1
Ruijie# telnet 192.168.1.1 /source interface vlan 1 /vrf vpn1
2          telnet          IPV6          2AAA:BBBB::CCCC
Ruijie# telnet 2AAA:BBBB::CCCC

```

┌

ip telnet source-interface	IP Telnet
show session	TTY
exit	

┌

┌

-	-

2.1.19 username

<i>password</i>	
07	0 7
<i>encrypted-password</i>	
<i>privilege-level</i>	

	<i>message</i>	
	Ruijie(config) Ruijie(config)# banner login \$ <i>enter your password</i> \$	
	-	-
	-	-

2.2.2 banner motd

	no banner motd	banner motd
	banner motd <i>c message c</i>	
	<i>c</i>	
	<i>message</i>	



```

Ruijie#show boot system
system boot file: flash:/rgos.bin

Ruijie#dir
Directory of flash:/
   11015744 2008-01-01 08:00:46  rgos.bin
   12019754 2008-02-01 08:00:46  s5750_10_4.bin
     399 2006-01-01 08:01:37  config.text
33,030,144 bytes total. (10,590,592 bytes free)

Ruijie(config)# boot system s5750_10_4.bin
Ruijie(config)# show boot system
system boot file: flash:/ s5750_10_4.bin
                        s5750_10_4.bin

```

show boot system	

-

-	-

2.2.4 clock set

clock set

clock set *hh:mm:ss month day year*

<i>hh:mm:ss</i>	24 : :
<i>day</i>	1-31
<i>month</i>	1-12
<i>year</i>	1993-2035

|

|

|

clock set

|

2003 3 17 10 20 30

Ruijie# **clock set** 10:20:30 3 17 2003

Ruijie# **show clock**

clock: 2003-3-17 10:20:32

|

show clock	

|

|

-	-

2.2.5 clock update-calendar

clock update-calendar

|

-	-

|

|

|

calendar

Ruijie# clock update-calendar



L

--	--

-

- ÎB1u)ÓÞÛ

AGÅ´



└───
└───
└───
└───

```
10
Ruijie# reload in 10
Router will reload in 600 seconds.
```

-	-

└───

└───

-	-

2.2.10 session-timeout

```
LINE                                session-timeout
no session-timeout                 LINE
session-timeout minutes [output]
no session-timeout
```

└───

<i>minutes</i>	
output	

└───

0 min

└───

LINE

└───

```
LINE
LINE
```

└───

```
line vty 0                5 30
```

```
Ruijie(config-line)# exec-timeout 5 30
```

-	-

-	-

2.2.11 speed

speed speed

no speed

speed speed

<i>Speed</i>	bps 9600 19200 38400 57600 115200 9600

9600

57600 bps

```
Ruijie(config)# line console 0
```

```
Ruijie(config-line)# speed 57600
```

-	-

--	--

	-	-
--	---	---

2.2.12 write

running-config

write [memory | network | terminal]

memory	NVRAM copy running-config startup-config
network	TFTP copy running-config tftp
terminal	show running-config

```

[Failed]
The device [usb1] does not exist, write to the default config file
[/config.text]? [no] yes
Write to the default config file: [/config.text]
[OK]

```

boot config	
copy	
show running-config	

-	-

2.3

2.3.1 show clock

show clock

show clock

-	-

detail

show clock

```

Ruijie# show clock
clock: 2003-3-17 10:27:21

```

clock set	

└───┘

-	-

2.3.2 show line

show line

show line [*console line-num* | *aux line-num* | *vty line-num* | *line-num*]

console	
aux	aux
vty	vty
<i>line-num</i>	line

└───┘

└───┘

└───┘

```

                                console
Ruijie# show line console 0
CON   Type   speed  Overruns
* 0   CON    9600  45927
Line 0, Location: "", Type: "vt100"
Length: 24 lines, Width: 79 columns
Special Chars: Escape Disconnect Activation
                ^^x   none      ^M
Timeouts:      Idle EXEC   Idle Session
                never     never
History is enabled, history size is 10.

```

```
Total input: 53564 bytes
Total output: 395756 bytes
Data overflow: 27697 bytes
stop rx interrupt: 0 times
```

-	-

-	-

2.3.3 show reload

show reload

show reload

-	-

```
Ruijie# show reload
Reload scheduled in 595 seconds.
At 2003-12-29 11:37:42
Reload reason: test.
```

-	-

	-	-

2.3.4 show running-config

show running-config

show running-config

	-	-

|

|

|

|



	-	-

|

--	--

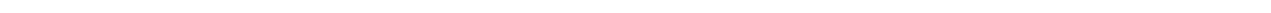
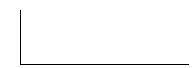
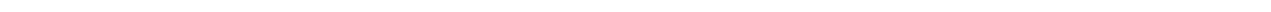

By Ruijie Network

System start time: 1970-6-14 11:49:53

System uptime: 3:17:1:17

System hardware version: 2.0

System software version: RGOS 10.3.00(4), Release(34679)

System boot version: 10.2.34077

System CTRL version: 10.2.24136

System serial number: 1234942570001

-	-

-	-

3 LINE

3.1 LINE

3.1.1 access-class

Line ACL **access-class** *acl-no* { **in** | **out** }
Line no **access-class** *access-list-number* { **in** | **out** }
LINE ACL
[no] **access-class** *access-list-number* { **in** | **out** }

LINE

	-	-

3.1.2 line

LINE

line [**aux** | **console** | **tty** | **vty**] *first-line* [*last-line*]

aux		
console		
tty		
vty		telnet/ssh
<i>First-line</i>		first-line
<i>Last-line</i>		last-line

|

|

|

LINE

|

```
LINE VTY 1 3 LINE
Ruijie(config)# line vty 1 3
```

|

	-	-

|

|

	-	-

3.1.3 line vty

VTY VTY no
line vty *line-number*
no line vty *line-number*

	-	-

VTY 5 0-4

VTY

1 VTY 20 VTY 0--19
Ruijie(config)# **line vty 19**
2 VTY 10 VTY 0—9
Ruijie(config)# **line vty 10**

	-	-

	-	-

3.1.4 transport input

Line **transport input** Line
default transport input LINE

transport input {all | ssh | telnet | none}

default transport input

all	Line	
ssh	Line	SSH

LINE

telnet	Line	Telnet
none	Line	

VTY TTY NONE
default transport input

Line

Line VTY VTY **show**
running Line
/ input default transport input no transport
transport input none

```

line vty 0 4 telnet
Ruijie# configure terminal
Ruijie(config)# line vty 0 4
Ruijie(config-line)# transport input telnet

```

show running	
---------------------	--

RGOS10.1

-	-
---	---

4

4.1

4.1.1 ping

ping [*vrf vrf-name*] [*ip*] [*ip-address* [*length length*]] [*ntimes times*] [*timeout seconds*] [*data data*] [*source source*] [*df-bit*] [*validate*]



DNS

1 ping

```
Ruijie# ping 192.168.5.1
```

```
Sending 5, 100-byte ICMP Echoes to 192.168.5.1, timeout is 2 seconds:
```

```
< press Ctrl+C to break >
```

```
!!!!
```

```
Success rate is 100 percent (5/5), round-trip min/avg/max = 1/2/10 ms
```

2 ping

```
Ruijie# ping 192.168.5.197 length 1500 ntimes 100 timeout 3 data ffff source 192.168.4.10
```

```
Sending 100, 1000-byte ICMP Echoes to 192.168.5.197, timeout is 3 seconds:
```

```
< press Ctrl+C to break >
```

```
!!!!!!!!!!!!!!!!!!!!!!!!!!!!!!!!!!!!!!!!!!!!!!!!!!!!!!!!!!!!!!!!!!!!!!!!!!!!  
!!!!!!!!!!!!!!!!!!!!!!!!!!!!!!!!!!!!!!!!!!!!!!!!!!!!!!!!!!!!!!!!!!!!!!!!!!!!
```

```
Success rate is 100 percent (100/100), round-trip min/avg/max = 2/2/3 ms
```

-	-

-	-

4.1.2 ping ipv6

```
ping [ipv6] [ip-address [length length ] [ntimes times] [timeout seconds] [data data]  
[source source]
```

<i>ip-address</i>	IPv6

<i>length</i>	
<i>times</i>	
<i>seconds</i>	
<i>data</i>	
<i>source</i>	IPv6 ::1

2 5 100Byte IP

```

Ping ipv6
  ping ipv6
  ping ipv6
    2            5            100Byte            IP
    '!'                    ':'
      'C'
      ping
ping ipv6
  
```

	-	-
	ipv6	
	-	-

4.1.3 traceroute

traceroute

traceroute [**vrf**] [*vrf-name*] [**ip** *ip-address*][*ip-address* [**probe** *number*] [**source** *source*]
 [**timeout** *seconds*] [**ttl** *minimum maximum*]

<i>vrf-name</i>	VRF
<i>ip-address</i>	IPv4
<i>number</i>	
<i>source</i>	IPv4 127.0.0.1
<i>seconds</i>	
<i>minimum maximum</i>	

```

2      192.168.9.2      4 msec  4 msec  4 msec
3      192.168.9.1      8 msec  8 msec  4 msec
4      192.168.0.10     4 msec  28 msec 12 msec
5      202.101.143.130  4 msec  16 msec  8 msec
6      202.101.143.154 12 msec  8 msec  24 msec
7      61.154.22.36    12 msec  8 msec  22 msec
                                     IP      61.154.22.36
1 6

```

2 traceroute

```

Ruijie# traceroute 202.108.37.42
< press Ctrl+C to break >
Tracing the route to 202.108.37.42
1      192.168.12.1     0 msec  0 msec  0 msec
2      192.168.9.2      0 msec  4 msec  4 msec
3      192.168.110.1    16 msec 12 msec 16 msec
4      * * *
5      61.154.8.129    12 msec 28 msec 12 msec
6      61.154.8.17     8 msec 12 msec 16 msec
7      61.154.8.250    12 msec 12 msec 12 msec
8      218.85.157.222 12 msec 12 msec 12 msec
9      218.85.157.130 16 msec 16 msec 16 msec
10     218.85.157.77   16 msec 48 msec 16 msec
11     202.97.40.65    76 msec 24 msec 24 msec
12     202.97.37.65    32 msec 24 msec 24 msec
13     202.97.38.162   52 msec 52 msec 224 msec
14     202.96.12.38    84 msec 52 msec 52 msec
15     202.106.192.226 88 msec 52 msec 52 msec
16     202.106.192.174 52 msec 52 msec 88 msec
17     210.74.176.158 100 msec 52 msec 84 msec
18     202.108.37.42   48 msec 48 msec 52 msec
                                     IP      202.108.37.42
1 17 4

```

```

Ruijie# traceroute www.ietf.org
Translating " www.ietf.org "...[OK]
< press Ctrl+C to break >
Tracing the route to 64.170.98.32
1      192.168.217.1    0 msec  0 msec  0 msec
2      10.10.25.1       0 msec  0 msec  0 msec

```

```

3      10.10.24.1      0 msec  0 msec  0 msec
4      10.10.30.1     10 msec  0 msec  0 msec
5      218.5.3.254    0 msec  0 msec  0 msec
6      61.154.8.49    10 msec  0 msec  0 msec
7      202.109.204.210 0 msec  0 msec  0 msec
8      202.97.41.69   20 msec  10 msec  20 msec
9      202.97.34.65   40 msec  40 msec  50 msec
10     202.97.57.222   50 msec  40 msec  40 msec
11     219.141.130.122 40 msec  50 msec  40 msec
12     219.142.11.10  40 msec  50 msec  30 msec
13     211.157.37.14  50 msec  40 msec  50 msec
14     222.35.65.1    40 msec  50 msec  40 msec
15     222.35.65.18   40 msec  40 msec  40 msec
16     222.35.15.109  50 msec  50 msec  50 msec
17     *      *      *
18     64.170.98.32   40 msec  40 msec  40 msec

```

-	-

-

-	-

4.1.4 traceroute ipv6

traceroute ipv6

traceroute [ipv6 ip-address] [probe number] [timeout seconds] [ttl minimum maximum]

<i>ip-address</i>	IPv6
<i>number</i>	
<i>seconds</i>	
<i>minimum maximum</i>	TTL

Traceroute ipv6

DNS

traceroute ipv6

1 traceroute ipv6

Ruijie# **traceroute ipv6 3004::1**

< press Ctrl+C to break >

Tracing the route to 3004::1

1	3000::1	0 msec	0 msec	0 msec
2	3001::1	4 msec	4 msec	4 msec
3	3002::1	8 msec	8 msec	4 msec
4	3004::1	4 msec	28 msec	12 msec

IP 3004::1

1 4

2 traceroute ipv6

Ruijie# **traceroute ipv6 3004::1**

< press Ctrl+C to break >

Tracing the route to 3004::1

1	3000::1	0 msec	0 msec	0 msec
2	3001::1	4 msec	4 msec	4 msec
3	3002::1	8 msec	8 msec	4 msec
4	* * *			
5	3004::1	4 msec	28 msec	12 msec

IP 3004::1

1 5 4

-	-

--	--	--

5

5.1

5.1.1 carrier

no

carrier-delay [seconds

no carrier-delay

ds

2

DCD

DCD

	-	-
--	---	---

5.1.2 clear counters

clear counters [*interface-id*]

	<i>interface-id</i>	

|

|

	show interfaces	clear
counters		

Ruijie# **clear counters gigabitethernet 1/1**

	show interfaces	

|

	-	-

5.1.3 clear interface

clear interface *interface-id*

	<i>interface-id</i>	

|

┌

┌

Switch Port,L2 Aggregate port ,Routed port,L3 Aggregate port
shutdown no shutdown

┌

Ruijie# **clear interface gigabitethernet 1/1**

┌

shutdown	

┌

┌

-	-

5.1.4 description

no

description *string*

no description

┌

<i>string</i>	

┌

┌

┌

show interfaces

┌

Ruijie(config)# **interface gigabitethernet 1/1**
Ruijie(config-if)# **description GBIC-1**

┌

show interfaces	

	-	-

5.1.5 duplex

no

duplex {auto | full | half}

no duplex

	auto	
	full	
	half	

└───

└───

└───

show interfaces

└───

Ruijie(config-if)# **duplex full**

--	--	--

no

flowcontrol {auto | off | on}

no flowcontrol

auto	
off	
on	

└───┘

└───┘

└───┘

show interfaces

└───┘

1/1

Ruijie(config)# **interface gigabitethernet 1/1**

Ruijie(config-if)# **flowcontrol on**

show interfaces	

└───┘

-	-

5.1.7 interface aggregateport

no

interface aggregateport *port-number*

<i>port-number</i>	Aggregate port

└───┘

start cable-diagnoses,please wait...

cable-daignoses end!this is result:

4 pairs

pair state length(meters)

A Ok 1

pair state length(meters)

B Ok 2

pair state length(meters)

C Short 1

pair state length(meters)

D Short 1

pairs	
state	OK Short Open A B OK C D
length	Short A B C D OK state OK Short Open length

-	-

86/96
M8600_48GT_4SFP_POE_II M9600_48GT_4SFP_POE_II
M8600_48GT_4SFP_E M9600_48GT_4SFP_E
M8600_48GT_4SFP_E_II M9600_48GT_4SFP_E_II

5.1.12 medium-type

no

medium-type { fiber | copper }

no medium-type

fiber	
copper	

┌

┌

Ap SVI

┌

```
Ruijie(config)# interface gigabitethernet 1/1
Ruijie(config-if)# medium-type copper
```

show interfaces	

┌

```
24SFP/12GT      12 SFP      12 10/100/1000M BASE-T
                  SFP      10/100/1000M BASE-T
```

-	-

5.1.13 mtu

mtu

Mtu num

<i>num</i>	64 9216(65536)

┌

1500

┌

mtu

```
Ruijie(config)# interface gigabitethernet 1/1  
Ruijie(config-if)# mtu 9216
```

show interfaces	

-	-

5.1.14 shutdown

no

shutdown

no shutdown

-	-

Ap SVI

show interfaces

no shutdown

```
1      Ap 1  
Ruijie(config)# interface aggregateport 1  
Ruijie(config-if)# shutdown  
2      Ap 1  
Ruijie(config)# interface aggregateport 1
```

```
Ruijie(config-if)# no shutdown
```

clear interface	
show interfaces	

-	-

5.1.15 snmp trap link-status

SNMP LinkTrap, LinkTrap no SNMP Link

LinkTrap

snmp trap link-status

no snmp trap link-status

Link SNMP LinkTrap

Ap SVI LinkTrap

Link SNMP LinkTrap,

```
1 Link trap
Ruijie(config)# interface gigabitEthernet 1/1
Ruijie(config-if)# no snmp trap link-status
2 Link trap
Ruijie(config)# interface gigabitEthernet 1/1
Ruijie(config-if)# snmp trap link-status
```

Ruijie(config-if)# snmp trap link-status	link trap
Ruijie(config-if)# no snmp trap link-status	link trap

-	-

5.1.16 speed

no

10	10Mbps
100	100Mbps
1000	1000Mbps
10G	10Gbps
auto	

Ap

Ap

Ap

show interfaces
SFP

È



switchport trunk {allowed vlan {all | [add | remove | except] *vlan-list* }} native vlan *vlan-id*}

no switchport trunk {allowed vlan | native vlan}

	Trunk	VLAN	<i>vlan-list</i>
	VLAN		VLAN
	VLAN ID	VLAN ID	-
	10-20	,	
	1-10,20-25,30,33		
allowed vlan <i>vlan-list</i>	all	VLAN	VLAN
	add	VLAN	VLAN
	remove	VLAN	VLAN
	except	VLAN	VLAN
	VLAN		
native vlan <i>vlan-id</i>	Native VLAN		

VLAN all Native VLAN VLAN 1

```

Access vlan is 1,Native vlan is 1
Protected is disabled
Vlan lists is
1,3-4094

```

show interfaces			
switchport access		accessport	statics VLAN

-		-	

5.2

5.2.1 show interfaces

show interfaces [*interface-id*] [**counters** | **description** | **status** | **switchport** | **trunk** | **transceiver** [**alarm** | **diagnosis**]]

<i>interface-id</i>	loopback	aggregateport	SVI
counters			
description		link	
status			
switchport			
trunk	trunking port	Aggregate port	
transceiver			
alarm	" None"		

diagnosis	
------------------	--

```
Ruijie# show interfacesgigabitEthernet 0/1 switchport
Interface Switchport ModeAccess Native Protected VLAN lists
-----
GigabitEthernet 0/1 enabled Access 11 Disabled ALL
```

duplex	
flowcontrol	
interface gigabitEthernet	
interface aggregateport	
interface vlan	switch virtual interface SVI
shutdown	
speed	
switchport priority	802.1q
switchport protected	

6 Aggregate Port

6.1

6.1.1 aggregateport load-balance

AP no

aggregateport load-balance {dst-mac | src-mac | src-dst-mac | dst-ip | src-ip | src-dst-ip }

no aggregateport load-balance

dst-mac		MAC		AP
		MAC		
		MAC		
src-mac		MAC		AP
		MAC		
		MAC		
src-dst-ip	IP	IP		IP—
	IP			IP—
	IP			
dst-ip		IP		AP
	IP			
src-ip		IP		AP
		IP		
		IP		
src-dst-mac	MAC	MAC		
	MAC—	MAC		
	MAC—	MAC		

MAC

show aggregateport load-balance

Ruijie(config)# **aggregateport load-balance dst-mac**

show aggregateport load-balance	aggregateport

-	-

6.1.2 port-group

Aggregate Port

no

Aggregate Port

port-group *port-group-number*

no port-group

<i>port-group-number</i>	Aggregate Port Port Aggregate

Aggregate Port

AP VLAN trunk port native
 VLAN AP

1/3 AP 3

Ruijie(config)# **interface gigabitethernet 1/3**

Ruijie(config-if)# **port-group 3**

-	-

┌

┌

-	-

6.2

6.2.1 show aggregateport

aggregateport

┌

<i>aggregate-port-number</i>	Aggregate Port
load-balance	aggregaye port
summary	aggregate port

┌

┌

┌

aggregate port

aggregate port

┌

```
Ruijie# show aggregateport 1 summary
AggregatePort MaxPorts      SwitchPort Mode  Ports
-----
Ag1            8              Enabled  ACCESS
```

┌

aggregateport load-balance	AP

┌

┌

-	-

7 VLAN

7.1

7.1.1 name

VLAN **no**

name *vlan-name*

no name

	<i>vlan-name</i>	VLAN

VLAN	VLAN	VLAN ID	VLAN 2	"VLAN0002"
------	------	---------	--------	------------

VLAN		
------	--	--

show vlan	vlan	
------------------	------	--

```
Ruijie(config)# vlan 10
Ruijie(config-vlan)# name vlan10
```

show vlan		VLAN

--	--	--

-		-

7.1.2 switchport access

no access port VLAN VLAN

switchport access vlan *vlan-id*

no switchport access vlan

access	switch port	access port
trunk	switch port	trunk port
hybrid	switch port	hybrid port

no switchport trunk {allowed vlan | native vlan }

allowed vlan <i>vlan-list</i>	Trunk	VLAN	vlan-list
	VLAN		VLAN
	VLAN ID	VLAN ID	-
	10-20		,
	1-10,20-25,30,33		
	all	VLAN	VLAN
	add	VLAN	VLAN
	remove	VLAN	VLAN
	except	VLAN	VLAN
	VLAN		
native vlan <i>vlan-id</i>	Native VLAN		

VLAN all Native VLAN VLAN 1

Native VLAN

Trunk native VLAN native VLAN

UNTAG VLAN VLAN ID

IEEE 802.1Q PVID native VLAN VLAN ID Trunk

native VLAN UNTAG

VLAN

Trunk VLAN 1 4094

Trunk VLAN VLAN Trunk

show interfaces switchport

```

VLAN 2                      1/15
Ruijie(config)# interface fastethernet 1/15
Ruijie(config-if)# switchport trunk allowed vlan remove 2
Ruijie(config-if)# end
Ruijie# show interfaces fastethernet1/15 switchport
Interface  Switchport Mode  Access Native Protected VLAN lists
-----
FigabitEthernet 1/15  enabled TRUNK 1 1 Disabled 1,3-4094
    
```

--	--	--

VLAN

-	-
---	---

7.2

7.2.1 show vlan

VLAN

show vlan [id *vlan-id*]

<i>vlan-id</i>	VLAN ID

end **Ctrl+C**
exit

```
Ruijie# show vlan id 1  
VLAN Name                    Status    Ports  
-----  
  1 VLAN0001                  STATIC    Fa0/1, Fa0/2
```

name	VLAN
switchport access	Vlan

-	-
---	---

8 Private VLAN

8.1

8.1.1 private-vlan association

secondary VLAN primary VLAN

private-vlan association {*svlist* | **add** *svlist* | **remove** *svlist*}

no private-vlan association

private-vlan mapping {*svlist* | **add** *svlist* | **remove** *svlist*}

no private-vlan mapping

<i>svlist</i>	secondary VLAN list
no	

|

Primary VLAN

|

```
Ruijie(config)# interface vlan 22
Ruijie(config-if)# private-vlan mapping add 24-26
```

show vlan private-vlan	-

RGOS10.1

-	-

8.1.3 private-vlan type

VLAN VLAN

private-vlan {*community* | *isolated* | *primary*}

no private-vlan {*community* | *isolated* | *primary*}

<i>community</i>	community VLAN
<i>isolated</i>	isolated VLAN
<i>primary</i>	primary VLAN
<i>no</i>	VLAN

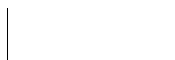

VLAN



VLAN



```
Ruijie(config)# vlan 22
```

```
Ruijie(config-vlan)# private-vlan primary
```



show vlan private-vlan	-

```
RGOS10.1
```

-	-

8.1.5 switchport private-vlan host-association

private VLAN

primary VLAN

secondary VLAN

switchport private-vlan host-association *p_vid s_vid*

no switchport private-vlan host-association

<i>p_vid</i>	primary VID
<i>s_vid</i>	secondary VID
no	VLAN

```
Ruijie(config)# interface gigabitEthernet 0/1
Ruijie(config-if)# switchport mode private-vlan host
Ruijie(config-if)# switchport private-vlan host-association 22 23
```

```
OS 1 1.006 T...
```

show vlan private-vlan [community | primary | isolated]

primary	primary VLAN
community	community VLAN
isolated	isolated VLAN

private VLAN

Ruijie# **show vlan private-vlan**

-	-

RGOS10.1

-	-

8.3 Hybrid

8.3.1 switchport hybrid allowed vlan

switchport hybrid allowed vlan[[add][tagged | untagged] | remove] *vlist*

no switchport hybrid allowed vlan

hybrid

no	hybrid

L

L

L

L

L

L

L

L

L

	-	-

8.3.3 switchport mode hybrid

switchport mode hybrid

no switchport mode

hybrid

no		hybrid

|

|

|

|

Ruijie(config-if)# **switchport mode hybrid**

--	--

QinQ

9 QinQ

9.1

9.1.1 dot1q outer-vid vid register inner-vid v_list

	-	-
--	---	---

9.1.2 dot1q relay-vid vid translate local-vid v-list

access trunk hybrid uplink

vid

dot1q relay-vid *vid* **translate local-vid** *v-list*

no dot1q relay-vid *vid* **translate local-vid** *v-list*

<i>v_list</i>		vid
<i>vid</i>	tag	vid
no		

┌

┌

┌

```

tag vid 10-20 vid 100
ruijie(config)# interface gigabitEthernet 0/1
ruijie(config-if)# switchport mode access
ruijie(config-if)#

```

dot1q relay-vid *vid* **translate inner-vid** *v-list*

no dot1q relay-vid *vid* **translate inner-vid** *v-list*

<i>v_list</i>	vid
<i>vid</i>	tag vid
no	

└───

└───

└───

```

tag
tag
ruijie# configure
ruijie(config)# interface gigabitEthernet 0/2
ruijie(config-if)# dot1q-Tunnel cos 3 remark-cos 5
ruijie(config-if)# end
    
```

show interface intf-name remark	-

└───

-	-

9.1.5 frame-tag tpid tpid

tpid

frame-tag tpid <tpid>

no frame-tag tpid

└───

no	tpid

└───

└───

(5760)

└───

```

tpid 0x9100
ruijie(config)# interface g 0/3
    
```

```
ruijie(config-if)# frame-tag tpid 0x9100
ruijie(config-if)# end
ruijie# show frame-tag tpid
Ports  tpid
-----  -----
Gi0/3   0x9100
```

	Q,
--	----

	show inner-priority-trust	-
	RGOS10.1	
	-	-

9.1.7 mac-address-mapping x source-vlan src-vlan-list

destination-vlan dst-vlan-id

vlan mac vlan

mac-address-mapping x destination-vlan dst-vlan-id source-vlan src-vlan-list

no mac-address-mapping x destination-vlan dst-vlan-id source-vlan src-vlan-list

	no	vlan vlan

┌

└

┌

└

tag tag

ruijie#**configure**

-	-

9.1.8 switchport mode dot1q-tunnel

dot1q-tunnel

switchport mode dot1q-tunnel

no switchport mode

no	dot1q-tunnel

dot1q-tunnel

```

dot1q-tunnel
ruijie(config)# interface gigabitEthernet 0/1
ruijie(config-if)# switchport mode dot1q-tunnel
ruijie(config)# end
    
```

show vlan	-

RGOS10.1

-	-

9.1.9 switchport mode uplink

uplink

switchport mode uplink

no switchport mode

no		uplink

```
uplink
```

```

uplink
ruijie(config)#interface gigabitEthernet 0/1
ruijie(config-if)#switchport mode uplink
ruijie(config)#end

```

show vlan		-

```
RGOS10.1
```

-		-

9.1.10 switchport dot1q-tunnel allowed vlan

```
dot1q-tunnel    vlan
```

```
switchport dot1q-tunnel allowed vlan [add] {tagged|untagged} v_list
```

```
switchport dot1q-tunnel allowed vlan remove v_list
```

```
no switchport dot1q-tunnel allowed vlan
```

tagged		tag
untagged		tag
<i>v_list</i>		vlan id
no		

```
vlan 1 untagged
```

|

|

|

```

dot1q-tunnel    vlan 3-6    vlan    tag
ruijie(config)#interface gigabitEthernet 0/1
ruijie(config-if)#switchport dot1q-tunnel allowed vlan tagged 3-6
ruijie(config)#end
    
```

|

show interface dot1q-tunnel	-

|

RGOS10.3

|

-	-

9.1.11 switchport dot1q-tunnel native vlan

dot1q-tunnel vlan id

switchport dot1q-tunnel native vlan *vid*

no switchport dot1q-tunnel native vlan

|

<i>vid</i>	vlan id
no	vlan 1

|

vlan 1

|

|

|

```

dot1q-tunnel    vid 8
ruijie(config)# interface gigabitEthernet 0/1
ruijie(config-if)# switchport dot1q-tunnel native vlan 8
    
```

```
ruijie(config)#end
```

show interface dot1q-tunnel	-

```
RGOS10.3
```

-	-

9.1.12 traffic-redirect access-group acl outer-vlan

access,trunk,hybrid, uplink

vid

traffic-redirect access-group *acl* outer-vlan *vid* in

no traffic-redirect access-group *acl* outer-vlan

<i>acl</i>	acl
<i>vd</i>	vid
no	vid

```
1.1.1.1
```

```
vid
```

```
3
```

```
ruijie#configure
```

```
ruijie(config)#ip access-list standard 2
```

```
ruijie(config-acl-std)#permit host 1.1.1.1
```

```
ruijie(config-acl-std)#exit
```

```
ruijie(config)# interface gigabitEthernet 0/1
```

```
ruijie(config-if)# switchport mode trunk
```

```
ruijie(config-if)# traffic-redirect access-group 2 outer-vlan 3 in
```

```
ruijie(config-if)# end
```

show traffic-redirect	-

RGOS10.3

-	-

9.1.13 traffic-redirect access-group acl nested-vlan

dot1q-tunnel

vid

traffic-redirect access-group *acl* nested-vlan *vid* in

no traffic-redirect access-group *acl* nested -vlan

<i>acl</i>	acl
<i>vid</i>	vid
no	vid

┌

┌

┌

```

1.1.1.3          vid  9

ruijie# configure
ruijie(config)# ip access-list standard 20
ruijie(config-acl-std)# permit host 1.1.1.3
ruijie(config-acl-std)# exit
ruijie(config)# interface gigabitEthernet 0/1
ruijie(config-if)# switchport mode dot1q-tunnel
ruijie(config-if)# traffic-redirect access-group 20 nested-vlan 10
in
ruijie(config-if)# end

```

--	--

	show traffic-redirect	-
	RGOS10.1	
	-	-

9.1.14 l2protocol-tunnel

dot1q-tunnel

l2protocol-tunnel {stp|gvrp}

no l2protocol-tunnel {stp|gvrp}

	stp	stp
	gvrp	gvrp
	no	

```

gvrp stp
ruijie#configure
ruijie(config)# l2protocol-tunnel stp
ruijie(config)# l2protocol-tunnel gvrp
ruijie(config)#end

```

	show l2protocol-tunnel {gvrp stp}	-

RGOS10.3

--	--	--

	-	-
--	---	---

9.1.15 l2protocol-tunnel *proto-type* enable

l2protocol-tunnel { stp|gvrp } enable

no l2protocol-tunnel { stp|gvrp } enable

stp		stp
gvrp		gvrp
no		

|

|

|

|

```
ruijie# configure
ruijie(config)# interface fa 0/1
ruijie(config-if)# l2protocol-tunnel gvrp enable
ruijie(config-if)# end
```

show l2protocol-tunnel { gvrp stp }		-

|

RGOS10.3

|

|

-		-

9.1.16 l2protocol-tunnel *proto-type* tunnel-dmac *mac-address*

|

|

|

```
ruijie# show dot1q-tunnel
Ports  Dot1q-tunnel
-----  -----
Gi0/1  Enable
```

-	-

|

RGOS10.3

-	-

9.2.2 show frame-tag tpid

tpid

show frame-tag tpid [interface *intf-id*]

<i>intf-id</i>	

|

tpid

|

|

```
ruijie# show frame-tag tpid
```

dot1q-tunnel

show interface [*intf-id*] **dot1q-tunnel**



┌

┌

```
Ruijie# show interface intf-name remark
Ports          Type          From value  To value
-----
Gi0/1          Cos-To-Cos    3           5
```

┌

-	-

┌

RGOS10.1

┌

-	-

9.2.6 show interface mac-address-mapping x

MAC

show mac-address-mapping x

┌

-	-

┌

┌

┌

┌

```
ruijie# show mac-address-mapping 1
Ports          Destination-VID  Source-VID-list
-----
Gi0/1          5                1-3
```

┌

-	-

QinQ

<i>intf-id</i>	

┌

┌

┌

```

ruijie# show traffic-redirect
Ports          Type          VID  Match-filter
-----
Gi0/3          Mod-outer     23   11
Gi0/3          Mod-outer     3    4
Gi0/3          Mod-outer     6    5
Gi0/3          Mod-inner     8    inner-to-8
Gi0/6          Mod-inner     9    100
Gi0/7          Nested-vid    13   nest-13
    
```

-	-

RGOS10.3

-	-

9.2.9 show translation-table

access,trunk,hybrid vid

show translation-table [interface *intf-id*]

<i>intf-id</i>	

┌

Destination mac : 01d0f8000006

L2protocol-tunnel : gvrp Disable

-	-

RGOS10.3

-	-

10 Share VLAN

10.1

10.1.1 share

	share vlan	
	-	-
	vlan	
	share vlan no share	
	end	Ctrl+C
	exit	
	Ruijie(config)# vlan 2	
	Ruijie(config-vlan)# share	
	-	-
	-	-

10.2

10.2.1 show mac-address-table share

Status	duplicated share vlan	Status	original	Status
--------	-----------------------	--------	----------	--------

-	-	-	-	-

end Ctrl+C
exit

Ruijie# **show mac-address-table share**

Vlan	MAC Address	Type	Interface	Status
1	0040.4650.1e1e	DYNAMIC	Gigabit 0/1	original
2	0040.4650.1e1e	DYNAMIC	Gigabit 0/1	duplicated

-	-	-	-	-

-	-	-	-	-

11 MAC

11.1

11.1.1 address-bind

ip mac

address-bind *ip-address mac-address*

no address-bind *ip-address*

<i>ip-address</i>	IP
<i>mac-address</i>	mac

┌

┌

┌

IP MAC IP IP
MAC IP MAC

┌

```

ip 3.3.3.3 mac 00d0.f811.1112
Ruijie(config)# address-bind 3.3.3.3 00d0.f811.1112
    
```



/

address-bind install

no address-bind install

-	-

|

|

|

```

fa 0/1
Ruijie(config)# address-bind uplink fa0/1
Ruijie(config)# address-bind install
    
```

show address-bind uplink	

|

RGOS10.1

-	-

11.1.3 address-bind ip-address

ip mac .

address-bind ip-address mac-address

no address-bind ip-address

<i>ip-address</i>	IP
<i>mac-address</i>	mac

|

MAC

┌

┌

┌

┌

┌

┌

IP MAC IP IP
MAC IP MAC

ip 3.3.3.3 mac 00d0.f811.1112
Ruijie(config)# **address-bind 3.3.3.3 00d0.f811.1112**

show address-bind	

-	-

11.1.4 address-bind ipv6-mode

ip IP

address-bind ipv6-mode compatible

address-bind ipv6-mode loose

address-bind ipv6-mode strict

┌

┌

┌

┌

-	-

:

	Ipv4
	IPV4+MAC
	IPV4+MAC
	IPV4+MAC

	IPV6	
	ipv6	
	IPV6	
	MAC	MAC IPV6

```

IP      192.168.5.2      00d0.f822.33aa
IPV6
Ruijie# configure t
Enter configuration commands, one per line. End with CNTL/Z.
Ruijie(config)# address-bind 00d0.f822.33aa ip 192.168.5.2
Ruijie(config)# address-bind ipv6-mode compatible
    
```

-	-

-	-

11.1.5 address-bind uplink

```

ip      mac      .
address-bind uplink intf-id
no address-bind uplink intf-id
    
```

<i>intf-id</i>	

┌
└

┌
└

IP MAC IP IP
MAC IP MAC
(address-bind install)

┌
└

fa 0/1
Ruijie(config)#**address-bind uplink** fa0/1

┌
└

show address-bind uplink	

┌
└

RGOS10.1

┌
└

-	-

11.1.6 clear mac-address-table dynamic

clear mac-address-table dynamic[address *mac-addr*] [**interface** *interface-id*] [**vlan** *vlan-id*]

┌
└
┌
└
┌
└

dynamic	
address <i>mac-addr</i>	
interface <i>interface-id</i>	
vlan <i>vlan-id</i>	VLAN

┌
└
┌
└
┌
└

show mac-address-table dynamic

```
Ruijie# clear mac-address-table dynamic
```

show mac-address-table dynamic	

-	-

11.1.7 clear mac-address-table filtering

clear mac-address-table filtering [**address** *mac-addr*] [**vlan** *vlan-id*]

filtering	
address <i>mac-addr</i>	
vlan <i>vlan-id</i>	VLAN

```
show mac-address-table filtering
```

```
00d0.f800.0c0c
```

```
Ruijie# clear mac-address-table filtering address 00d0.f800.0c0c
```

mac-address-table filtering	
show mac-address-table filtering	

--	--	--

no mac-address-table aging-time



show mac-address-table filtering

Ruijie(config)# **mac-address-table filtering 00d0f8000000 vlan 1**

clear mac-address-table filtering	
show mac-address-table filtering	

-	-

11.1.11 mac-address-table notification

MAC **no**

mac-address-table notification [interval *value* | history-size *value*]

no mac-address-table notification [interval | history-size]

interval <i>value</i>	MAC	Trap	1
history-size <i>value</i>	MAC		50

1 50

MAC Trap
snmp-server enable traps mac-notification
 MAC Trap

Ruijie(config)# **mac-address-table notification**
 Ruijie(config)# **mac-address-table notification interval 40**
 Ruijie(config)# **mac-address-table notification history-size 100**



<code>show mac-address-table static</code>	

MAC

	-	
	-	

11.1.14 mac-address-learning

	mac-address-learning	
		MAC
	1	
	Ruijie(config-if)# no mac-address-learning	

11.2

11.2.1 show address-bind

	show address-bind	

|

|

```
Ruijie# show address-bind
IP Address      Binding MAC Addr
-----
3.3.3.3        00d0.f811.1112
3.3.3.4        00d0.f811.1117
```

|

address-bind	

|

|

-	-

11.2.2 show address-bind uplink

show address-bind uplink

|

|

|

|

|

```
Ruijie# show address-bind uplink
Ports      State
-----
Fa0/1      Disabled
Fa0/2      Disabled
```

MAC

|
|
|

.....

|
|
|

address-bind uplink	

|
|
|

|
|
|

-	-

11.2.3 show mac-address-table address

MAC

show mac-address-table [**address** *mac-addr*] [**interface** *interface-id*] [**vlan** *vlan-id*]

|
|
|
|
|

address <i>mac-addr</i>	MAC
interface <i>interface-id</i>	
vlan <i>vlan-id</i>	VLAN

|
|
|

|
|
|

|
|
|

Ruijie#

show mac-address-table interface	
show mac-address-table vlan	VLAN
show mac-address-table count	
show mac-address-table static	
show mac-address-table filtering	

|

--	--

--	--

11.2.5 show mac-address-table count

show mac-address-table count

-	-

--	--

--	--

--	--

```
Ruijie# show mac-address-table count
Dynamic Address Count : 51
Static Address Count : 0
Filter Address Count : 0
Total Mac Addresses : 51
Total Mac Address Space Available: 8139
```

show mac-address-table static	
show mac-address-table filtering	
show mac-address-table dynamic	
show mac-address-table address	
show mac-address-table interface	
show mac-address-table vlan	VLAN

--	--

-	-

11.2.6 show mac-address-table dynamic

show mac-address-table dynamic [**address** *mac-addr*] [**interface** *interface-id*] [**vlan** *vlan-id*]

<i>mac-addr</i>	MAC
<i>vlan-id</i>	VLAN
<i>interface-id</i>	(AggregatePort)

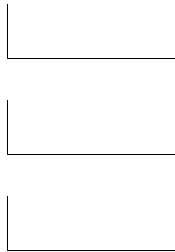

Ruijie# **show mac-address-table dynamic**

Vlan	MAC Address	Type	Interface
----	-----	-----	-----
1	0000.0000.0001	DYNAMIC	gigabitethernet 1/1
1	0001.960c.a740	DYNAMIC	gigabitethernet 1/1
1	0007.95c7.dff9	DYNAMIC	gigabitethernet 1/1
1	0007.95cf.eee0	DYNAMIC	gigabitethernet 1/1
1	0007.95cf.f41f	DYNAMIC	gigabitethernet 1/1
1	0009.b715.d400	DYNAMIC	gigabitethernet 1/1
1	0050.bade.63c4	DYNAMIC	gigabitethernet 1/1

clear mac-address-table dynamic	
--	--



-	-
---	---

11.2.7 show mac-address-table filtering

show mac-address-table static [**addr** *mac-addr*] [**vlan** *vlan-id*]

--	--

mac-addr

interface <i>interface-id</i>	MAC
<i>history</i>	MAC

MAC

```

Ruijie# show mac-address-table notification interface
Interface          MAC Added Trap  MAC Removed Trap
-----
GigabitEthernet1/14  Disabled        Disabled
Ruijie# show mac-address-table notification
MAC Notification Feature : Disabled
Interval between Notification Traps : 1 secs
Maximum Number of entries configured in History Table :1
Current History Table Length : 0
Ruijie# show mac-address-table notification history
History Index : 0
MAC Changed Message :
Operation:ADD Vlan : 1 MAC Addr: 00f8.d012.3456 GigabitEthernet 3/1
    
```

mac-address-table notification	MAC
snmp trap mac-notification	MAC

-	-
---	---

11.2.10 show mac-address-table static

show mac-address-table static [**addr** *mac-addr*] [**interface** *interface-id*] [**vlan** *vlan-id*]

<i>mac-addr</i>	MAC
<i>vlan-id</i>	VLAN
<i>interface-id</i>	(AggregatePort)

Ruijie# **show mac-address-table static**

```

Vlan    MAC Address      Type      Interface
-----  -
1       00d0.f800.1001   STATIC   gigabitethernet 1/1
1       00d0.f800.1002   STATIC   gigabitethernet 1/1
1       00d0.f800.1003   STATIC   gigabitethernet 1/1
    
```

mac-address-table static	
clear mac-address-table static	

-	-

11.2.11 show mac-address-table vlan

VLAN

show mac-address-table vlan [vlan-id]

<i>vlan-id</i>	VLAN ID

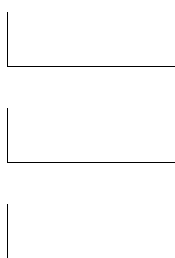

```
Ruijie# show mac-address-table vlan 1
Vlan    MAC Address      Type      Interface
-----  -
1       00d0.f800.1001   STATIC    gigabitethernet 1/1
1       00d0.f800.1002   STATIC    gigabitethernet 1/1
1       00d0.f800.1003   STATIC    gigabitethernet 1/1
```

show mac-address-table static	
show mac-address-table filtering	
show mac-address-table dynamic	
show mac-address-table address	
show mac-address-table interface	
show mac-address-table count	

|

1

12 DHCP Snooping

12.1 DHCP snooping

12.1.1 ip dhcp snooping

```
DHCP Snooping                                no
      DHCP Snooping
```

[no] ip dhcp snooping

-	-

└───

└───

DHCP Snooping	show ip dhcp snooping	DHCP
<hr/>		
⚡	DHCP Snooping	Private VLAN

└───

```

DHCP snooping
Ruijie# configure terminal
Ruijie(config)# ip dhcp snooping
Ruijie(config)# end
Ruijie# show ip dhcp snooping

Switch DHCP snooping status    ENABLE
Verification of hwaddr field status  DISABLE
DHCP snooping database write-delay time: 0 seconds
DHCP snooping option 82 status: ENABLE
DHCP snooping Support Bootp bind status: ENABLE
Interface                Trusted    Rate limit (pps)
-----                -

```

└───

--	--

show ip dhcp snooping		DHCP snooping
	-	-

12.1.2 ip dhcp snooping bootp-bind

```

DHCP Snooping      Bootp
no                  DHCP snooping      Bootp
    
```

[no] ip dhcp snooping bootp-bind

	-	-

```

                DHCP Snooping      Bootp
Snooping        Bootp              Bootp      DHCP
Snooping        Bootp              Bootp      DHCP
    
```

```

                DHCP Snooping      Bootp
Ruijie# configure terminal
Ruijie(config)# ip dhcp snooping bootp-bind
Ruijie(config)# end
Ruijie# show ip dhcp snooping
Switch DHCP snooping status      ENABLE
Verification of hwaddr field status  DISABLE
DHCP snooping database write-delay time: 0 seconds
DHCP snooping option 82 status: ENABLE
DHCP snooping Support Bootp bind status: ENABLE
Interface              Trusted          Rate limit (pps)
-----
    
```

show ip dhcp snooping	DHCP snooping
-	-

12.1.3 ip dhcp snooping database write-delay

```

DHCP Snooping          FLASH
                        no      FLASH
    
```

ip dhcp snooping database write-delay time

[no] ip dhcp snooping database write-delay

<i>time</i>	DHCP snooping	FLASH

FLASH

```

DHCP Snooping          FLASH
                        IP
    
```

```

flash          3600
    
```

```

Ruijie# configure terminal
Ruijie(config)# ip dhcp snooping database write-delay 3600
Ruijie(config)# end
Ruijie# show ip dhcp snooping
Switch DHCP snooping status   ENABLE
Verification of hwaddr field status   DISABLE
DHCP snooping database write-delay time: 3600seconds
DHCP snooping option 82 status: ENABLE
DHCP snooping Support Bootp bind status: ENABLE
Interface           Trusted      Rate limit (pps)
    
```

show ip dhcp snooping	DHCP snooping

-	-

12.1.4 ip dhcp snooping database write-to-flash

DHCP Snooping

FLASH

ip dhcp snooping database write-to-flash

-	-

└──

└──

-	-
---	---

12.1.5 ip dhcp snooping information option

DHCP option82
no

[no] ip dhcp snooping information option

-	-

┌

┌

┌

DHCP option82 DHCP option82

┌

```

DHCP                      option82
Ruijie# configure terminal
Ruijie(config)# ip dhcp snooping information option
Ruijie(config)# end
Ruijie# show ip dhcp snooping
Switch DHCP snooping status    ENABLE
Verification of hwaddr field status    DISABLE
DHCP snooping database write-delay time: 0 seconds
DHCP snooping option 82 status: ENABLE
DHCP snooping Support Bootp bind status: ENABLE
Interface                      Trusted      Rate limit (pps)
-----
```

┌

show ip dhcp snooping	DHCP snooping

┌

┌

--	--

[no] ip dhcp snooping verify mac-address

-	-

└───

└───

MAC DHCP	DHCP CLIENT CLIENT MAC	MAC	MAC
-------------	---------------------------	-----	-----

```

                DHCP      MAC
Ruijie# configure terminal
Ruijie(config)# ip dhcp snooping verify mac-address
Ruijie(config)# end
Ruijie# show ip dhcp snooping
Switch DHCP snooping status  ENABLE
Verification of hwaddr field status  ENABLE
DHCP snooping database write-delay time: 0 seconds
DHCP snooping option 82 status: ENABLE
DHCP snooping Support Bootp bind status: ENABLE
Interface                Trusted    Rate limit (pps)
-----                -

```

show ip dhcp snooping	DHCP snooping

└───

-	-

12.2 DHCP snooping

12.2.1 ip dhcp snooping limit rate

DHCP

no

[no] ip dhcp snooping limit rate *rate-value*

<i>rate-value</i>	PPS[Packet Per Second]

```

DHCP Snooping    VLAN
                  CPP[CPU Protect Protocol]    CPP    DHCP
                  CPP                          DHCP Snooping
CPP
show ip dhcp snooping
    
```

```

1                100pps
Ruijie# configure terminal
Ruijie(config)# interface fastEthernet 0/1
Ruijie(config-if)# ip dhcp snooping limit rate 100
Ruijie(config-if)# end
Ruijie# show ip dhcp snooping
Switch DHCP snooping status    ENABLE
Verification of hwaddr field status    DISABLE
DHCP snooping database write-delay time: 0 seconds
DHCP snooping option 82 status: ENABLE
DHCP snooping Support Bootp bind status: ENABLE
Interface                Trusted    Rate limit (pps)
-----                -
FastEthernet0/1          NO      100
    
```

show ip dhcp snooping	DHCP snooping

DHCP snooping TRUST
 no UNTRUST

[no] ip dhcp snooping trust

-	-

UNTRUST

	DHCP	DHCP	TRUST	TRUST
	DHCP	UNTRUST	DHCP	

```

fastEthernet 0/1 TRUST
Ruijie# configure terminal
Ruijie(config)# interface fastEthernet 0/1
Ruijie(config-if)# ip dhcp snooping trust
Ruijie(config-if)# end
Ruijie# show ip dhcp snooping
Switch DHCP snooping status    ENABLE
Verification of hwaddr field status    DISABLE
DHCP snooping database write-delay time: 0 seconds
DHCP snooping option 82 status: ENABLE
DHCP snooping Support Bootp bind status: ENABLE
Interface                      Trusted      Rate limit (pps)
-----
FastEthernet0/1                YES                unlimited
    
```



12.3 DHCP snooping

12.3.1 show ip dhcp snooping

┌

┌

-	-

12.3.2 show ip dhcp snooping binding

DHCP Snooping

show ip dhcp snooping binding

┌

-	-

┌

┌

┌

DHCP Snooping

```
Ruijie# show ip dhcp snooping binding
Total number of bindings: 1

MacAddress      IPAddress      Lease(sec)    Type          VLAN  Interface
-----
0000.0000.0001  1.1.1.1       78128         dhcp-snooping 1     FastEthernet 0/1
```

┌

ip dhcp snooping binding	DHCP snooping
clear ip dhcp snooping binding	DHCP snooping

┌

┌

--	--

DHCP Snooping

debug ip dhcp snooping {

13 IGMP Snooping

13.1

13.1.1 deny

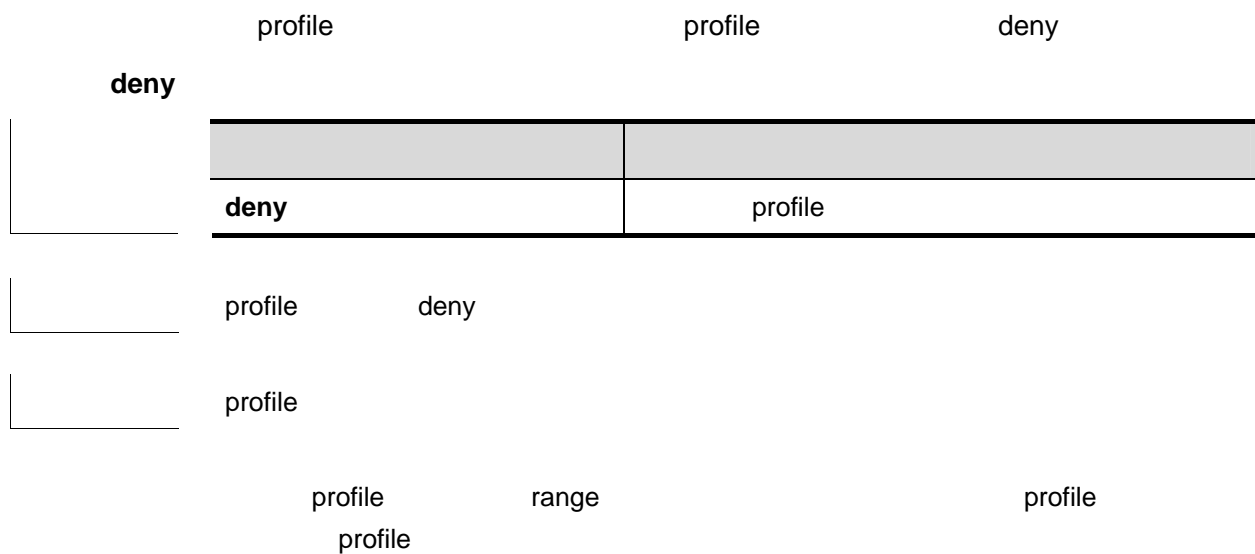

profile profile permit profile

permit

permit	profile

profile deny

profile

profile range profile
profile

224.2.2.2 profile
Ruijie(config)# **ip igmp profile 1**
Ruijie(config-profile)# **range 224.2.2.2**
Ruijie(config-profile)# **permit**

ip igmp profile	profile
range	

-	-

13.1.3 range

profile profile range
no

range *low-ip-address* [*high-ip-address*]

no range *low-ip-address* [*high-ip-address*]

<i>low-ip-address</i>	

	<i>high-ip-address</i>	
	profile	
	profile	profile deny
		profile
	224.2.2.2~224.2.2.244	profile
	Ruijie(config)# ip igmp profile 1	
	Ruijie(config-profile)# range 224.2.2.2 224.2.2.244	
	ip igmp profile	profile
	deny	profile deny
	permit	profile permit
	-	-

13.1.4 ip igmp profile

	IGMP profile	profile
	profile	profile-number igmp profile
	ip igmp profile <i>profile-number</i>	
	no ip igmp profile <i>profile-number</i>	
	<i>profile-number</i>	profile 1-65535

```

IGMP Profiles                               " SVGL                               " "
" " IGMP Filtering "                               profile
profile
    
```

```

1 profile profile
Ruijie(config)# ip igmp profile 1
Ruijie(config-profile)#
    
```

range	profile	
permit	profile	permit
deny	profile	deny

-	-

13.1.5 ip igmp snooping ivgl

```

igmp snooping ivgl
no igmp snooping
    
```

ip igmp snooping ivgl

ip igmp snooping ivgl

no ip igmp snooping

-	-

disable

VLAN

VLAN

VLAN

VLAN

```

pim snooping          igmp snooping  IVGL  IVGL-SVGL
no ip igmp snooping  igmp snooping
pim snooping          pim snooping
    
```

```

Ruijie(config)# ip igmp snooping ivgl
    
```

ip igmp snooping svgl	igmp snooping	svgl
ip igmp snooping ivgl-svgl	igmp snooping	

-	-
---	---

13.1.6 ip igmp snooping vlan

```

vlan          igmp snooping          ivgl          ip igmp
snooping vlan          no          igmp snooping
ip igmp snooping vlan vid
no ip igmp snooping vlan vid
    
```

vid	vlan id
-----	---------

disable

```

vlan          IGMP Snooping
vlan          pim snooping          igmp snooping
no ip igmp snooping vlan          igmp snooping
pim snooping          VLAN          pim snooping
    
```

SWA0>51q)0-7Aw6G6e4D4B6gE

	-	-

13.1.8 ip igmp snooping svgl profile

profile SVGL "

```
77 ID806 Td( )T/C Td(8.796 1 Tf-E3>JT/TT<350E2CD516/T1 1 Tf0 Tr 4.01/C)5fb1G4jv 14018 Tc 5.2390  
@ 17... U6  
}
```

no ip igmp snooping dyn-mr-aging-time

	<i>time</i>	, <1-3600>

300s

Hello

IGMP

PIM

100s

Ruijie(config)# **ip igmp snooping dyn-mr-aging-time 100**



```
IP          IGMP
```

```
igmp snooping fast-leave  
Ruijie(config)# ip igmp snooping fast-leave enable
```

```
© [REDACTED]
```

100s

Ruijie(config)# **ip igmp snooping query-max-response-time 100**

	ip igmp snooping limit-ipmc	ip
	-	-

13.1.13 ip igmp snooping limit-ipmc

no IP IP ip igmp snooping limit-ipmc vlan

ip igmp snooping limit-ipmc vlan *vid* **address** *gaddress* **server** *saddress*

no ip igmp snooping limit-ipmc vlan *vid* **address** *gaddress* **server** *saddress*

	<i>vid</i> ip	vlan id
	<i>gaddress</i>	
	<i>saddress</i>	()

IP

ip

```
Ruijie(config)# ip igmp snooping limit-ipmc vlan 1 address 224.0.0.1
server 192.168.4.243
```

		IP	IP
	ip igmp snooping source-check default-server		

--

	-	-

13.1.14 ip igmp snooping source-check port

```
igmp snooping
ip igmp snooping source-check port no
```

13.1.15 ip igmp snooping suppression enable

igmp snooping Report **ip igmp snooping**
suppression enable no igmp snooping suppression
ip igmp snooping suppression enable
no ip igmp snooping suppression enable



vid

vlan id

|

|

VLAN

no

VLAN

igmp snooping

|

vlan 1

Ruijie(config)# ip igmp snooping vlan 1 mrouter learn pim-dvmrp

|

ip igmp snooping mrouter learn pim-dvmrp	

|



	-
--	---

13.2

13.2.1 show ip igmp snooping

igmp snooping

Show ip igmp snooping [gda-table | interfaces | mrouter/ statistics [vlan *vlan-id*]

	igmp snooping
gda-table	
interfaces	igmp snooping filtering
mrouter	
statistics [vlan <i>vlan-id</i>]	snooping
vlan	vlan snooping

--	--

	EXEC
--	------

--	--

--	--

-	-

--	--

-	-

13.2.2 show ip igmp profile [profile-number]

		profile
<i>profile-number</i>		profile

┌

┌ EXEC

┌ profile

┌

	-	-

┌

	-	-

13.2.3 debug igmp-snp

IGMP Snooping Debug no

- debug igmp-snp**
- debug igmp-snp event**
- debug igmp-snp packet**
- debug igmp-snp msf**
- debug igmp-snp warning**
- undebug igmp-snp**
- undebug igmp-snp event**
- undebug igmp-snp packet**
- undebug igmp-snp msf**
- undebug igmp-snp warning**

--	--	--

	IGMP Snooping
event	IGMP Snooping
packet	IGMP Snooping
msf	IGMP Snooping
warning	IGMP Snooping

,GA:,XAA©

14 DHCPV6 Snooping

14.1

14.1.1 ipv6 dhcp snooping

```
dhcpv6 snooping no dhcpv6  
snooping
```

```
ipv6 dhcp snooping
```

```
no ipv6 dhcp snooping
```

	-	-

```
|
```

```
|
```

```
|
```

```
dhcpv6 snooping show ipv6 dhcp  
snooping dhcpv6 snooping
```

```
|
```

```
1 dhcpv6 snooping  
Ruijie(config)# ipv6 dhcp snooping
```

```
|
```

show ipv6 dhcp snooping	dhcpv6 snooping

```
|
```

no

ipv6 dhcp snooping binding-delay *seconds*

no ipv6 dhcp snooping binding-delay

<i>time</i>	

|

|

|

IPv6

1 10

Ruijie(config)# **ipv6 dhcp snooping binding-delay 10**

|

10.4	

14.1.3 ipv6 dhcp snooping database write-delay

dhcpv6 snooping

flash

no

ipv6 dhcp snooping database write-delay *time*

no ipv6 dhcp snooping database write-delay

--	--

|

|

dhcpv6 snooping flash
IP

|

1 flash 100
Ruijie(config)# ipv6 dhcp snooping database write-delay 100

|

show ipv6 dhcp snooping	dhcpv6 snooping

|

|

10.4	

14.1.4 ipv6 dhcp snooping database write-to-flash

|

dhcpv6 snooping flash
ipv6 dhcp snooping database write-to-flash

-	

|

|

dhcpv6 snooping flash
flash

	10.4	

14.1.5 ipv6 dhcp snooping filter-dhcp-pkt

	dhcpv6	no
	ipv6 dhcp snooping filter-dhcp-pkt	
	no ipv6 dhcp snooping filter-dhcp-pkt	
	dhcpv6	dhcpv6
	1	fastethernet 0/1 dhcpv6
	Ruijie(config)# interface fastethernet 0/1	
	Ruijie(config-if)# ipv6 dhcp snooping filter-dhcp-pkt	
	-	-
	10.4	

14.1.6 ipv6 dhcp snooping ignore dest-not-found

" " no DHCPv6

ipv6 dhcp snooping ignore dest-not-found

no ipv6 dhcp snooping ignore dest-not-found

--	--

└──

└──

DHCPv6	MAC	MAC	DHCPv6	MAC
" DHCPV6_SNOOPING-5-DEST_NOT_FOUND: Could not find destination port. Destination MAC [mac-address]"				
	MAC		DHCPv6	VLAN

1
Ruijie(config)# **ipv6 dhcp snooping ignore dest-not-found**

show ipv6 dhcp snooping	dhcpv6 snooping

└──

10.4	

14.1.7 ipv6 dhcp snooping link-detection

LINK DOWN no

ipv6 dhcp snooping link-detection

no ipv6 dhcp snooping link-detection

--	--	--

┌

┌

┌

LINK DOWN
LINK DOWN

┌

1 LINK DOWN
Ruijie(config)# **ipv6 dhcp snooping link-detection**

┌

show ipv6 dhcp snooping	dhcpv6 snooping

┌

10.4	

14.1.8 ipv6 dhcp snooping trust

dhcpv6 snooping trust no
untrust

ipv6 dhcp snooping trust

no ipv6 dhcp snooping trust

┌

--	--

┌

untrust

┌

┌

dhcpv6 untrust trust trust dhcpv6 Server
dhcpv6 Server

```

1          fastethernet 0/1  trust
Ruijie(config)# interface fastethernet 0/1
Ruijie(config-if)# ipv6 dhcp snooping trust
    
```

show ipv6 dhcp snooping	dhcpv6 snooping

10.4	

14.1.9 Ipv6 dhcp snooping vlan

```

vlan          dhcpv6 snooping          no
vlan          dhcpv6 snooping
    
```

ipv6 dhcp snooping {*vlan-list* | {*vlan-min* [*vlan-max*]}}

no ipv6 dhcp snooping {*vlan-list* | {*vlan-min* [*vlan-max*]}}

<i>vlan-list</i>	vlan 1,3-5,7,9-11
<i>vlan-min</i>	vlan id
<i>vlan-max</i>	vlan id

```

dhcpv6 snooping          vlan
    
```

```

dhcpv6 snooping          vlan  dhcpv6 snooping
vlan          dhcpv6 snooping          vlan          dhcpv6 snooping
    
```

```

1  vlan 1          dhcpv6 snooping
Ruijie(config)# no ipv6 dhcp snooping vlan 1
    
```

--	--

	-	-
	10.4	

14.1.10 ipv6 source binding

no

ipv6 source binding *mac-address* **vlan** *vlan-id* *ipv6-address* **interface** *interface-name*

no ipv6 source binding *mac-address* **vlan** *vlan-id* *ipv6-address* **interface** *interface-name*

<i>mac-address</i>	MAC
<i>vlan-id</i>	VLAN
<i>ipv6-address</i>	IPV6
<i>interface-name</i>	

IPV6 DHCPV6 IPV6

1

```
Ruijie(config)# ipv6 source binding 00d0.f866.4777 vlan 10
2001:2002::2003 interface fastethernet 0/10
```

--	--

10.4

14.1.11 ipv6 verify source

no

ipv6 verify source [port-security]

no ipv6 verify source

port-security	MAC + IPV6 IPV6 IPV6
	MAC IPV6

┌

┌

┌

IPV6

DHCPV6

IPV6

┌
 1 **fastethernet 0/1** MAC+IPV6
 Ruijie(config)# **interface fastethernet 0/1**
 Ruijie(config-if)# **ipv6 verify source port-security**

┌

┌

┌

10.4

14.2

14.2.1 show ipv6 dhcp snooping

dhcpv6 snooping

show ipv6 dhcp snooping

-	-

└───

└───

└───

dhcpv6 snooping

1 dhcpv6 snooping

Ruijie# show ipv6 dhcp snooping

Switch DHCPv6 snooping status ENABLE

DHCPv6 snooping vlan: 1-4094

DHCPv6 snooping database write-delay time: 0 seconds

DHCPv6 ignore dest-not-found :DISABLE

DHCPv6 snooping link detection :DISABLE

Interface	Trusted	Filter DHCP
-----	-----	-----
FastEthernet0/10	yes	DISABLE

└───

└───

└───

10.4	

14.2.2 show ipv6 dhcp snooping binding

dhcpv6 snooping

show ipv6 dhcp snooping binding [ipv6-address] [mac-address] [vlan vlan_id]
 [interface interface_name]

	vlan <i>vlan_id</i>	VLAN
	interface <i>interface_name</i>	

|

|

dhcpv6 snooping

dhcpv6 snooping

show ipv6 source binding [*ipv6-address*] [*mac-address*] [**vlan** *vlan_id*]
[**interface** *interface_name*] [**dhcp-snooping** | **static**]

14.3.1 clear ipv6 dhcp snooping binding

dhcpv6 snooping

clear ipv6 dhcp snooping binding [*ipv6-address*] [*mac-address*] [**vlan** *vlan_id*]
[**interface** *interface_name*]

<i>ipv6-address</i>	ipv6
<i>mac-address</i>	mac
vlan <i>vlan_id</i>	VLAN
interface <i>interface_name</i>	

dhcpv6 snooping

1 dhcpv6 snooping

Ruijie# **clear ipv6 dhcp snooping binding**

10.4	

14.3.2 clear ipv6 dhcp snooping prefix

dhcpv6 snooping

clear ipv6 dhcp snooping prefix [*ipv6-prefix*] [*mac-address*] [**vlan** *vlan_id*]
[**interface** *interface_name*]

--	--

<i>ipv6-prefix</i>	ipv6
<i>mac-address</i>	mac
vlan <i>vlan_id</i>	VLAN
interface <i>interface_name</i>	

┌

┌

┌

dhcpv6 snooping

┌
1 dhcpv6 snooping
Ruijie# **clear ipv6 dhcp snooping prefix**

┌

10.4	

14.3.3 clear ipv6 dhcp snooping statistics

dhcpv6 snooping dhcpv6

clear ipv6 dhcp snooping statistics

-	-

┌

┌

┌

dhcpv6 snooping dhcpv6

└───

	10.4	

15 ND Snooping

15.1

15.1.1 ipv6 nd snooping

```

IPv6 ND snooping
Snooping
no IPv6 ND
ipv6 nd snooping
no ipv6 nd snooping

```

--	--

--	--

```

ipv6 nd snooping

```

```

IPv6 ND snooping
Ruijie# configure terminal
Enter configuration commands, one per line. End with CNTL/Z.
Ruijie(config)# ipv6 nd snooping

```

show ipv6 nd snooping	ipv6 nd snooping

--	--

--	--

10.4(2)	

15.1.2 ipv6 nd snooping vlan

VLAN IPv6 ND snooping no VLAN
 IPv6 ND Snooping
ipv6 nd snooping vlan {vlan-rng | {vlan-min [vlan-max]}}
no ipv6 nd snooping vlan {vlan-rng | {vlan-min [vlan-max]}}

<i>vlan-rng</i>	vlan
<i>vlan-min</i>	vlan
<i>vlan-max</i>	vlan

vlan ipv6 nd snooping

```

1      VLAN 100  IPv6 ND Snooping
Ruijie# configure terminal
Enter configuration commands, one per line. End with CNTL/Z.
Ruijie(config)# no ipv6 nd snooping vlan 100

2      VLAN 4 5-7 15  IPv6 ND Snooping
Ruijie# configure terminal
Enter configuration commands, one per line. End with CNTL/Z.
Ruijie(config)# no ipv6 nd snooping vlan 4,5-7,15
    
```

show ipv6 nd snooping	ipv6 nd snooping

15.1.5 ipv6 nd snooping detect gateway

no

ipv6 nd snooping detect gateway ra
no ipv6 nd snooping detect gateway ra

VLAN

Ruijie#

<i>vlan-rng</i>	vlan
<i>vlan-min</i>	vlan
<i>vlan-max</i>	vlan

VALN

```
Ruijie# configure terminal
Enter configuration commands, one per line. End with CNTL/Z.
Ruijie(config)# ipv6 nd snooping detect gateway vlan 8
```

show ipv6 nd snooping	nd snooping

10.4(2)	

15.1.7 ipv6 nd snooping key-node

ND

no

```
ipv6 nd snooping key-node [link-local vid]ipv6_address/prefix_len
no ipv6 nd snooping key-node [link-local vid] ipv6_address/prefix_len
```

<i>vid</i>	link-local VID

<i>ipv6_address/prefix_len</i>	IPv6

```
Ruijie# configure terminal
Enter configuration commands, one per line. End with CNTL/Z.
Ruijie(config)#ipv6 nd snooping key-node 2003::1/128
```

show ipv6 nd snooping key-node	nd snooping

10.4(2)	

15.1.8 ipv6 nd snooping monitor stateless-user

no

```
ipv6 nd snooping monitor stateless-user
no ipv6 nd snooping monitor stateless-user
```

ND

Ruijie# **configure terminal**

Enter configuration commands, one per line. End with CNTL/Z.

Ruijie(config)#**no ipv6 nd snooping monitor stateless-user**

show ipv6 nd snooping stateless-user	

10.4(2)	

15.1.9 ipv6 nd snooping stateless-user combine-security

no

ipv6 nd snooping stateless-user combine-security

no ipv6 nd snooping stateless-user combine-security

```
Ruijie# configure terminal
Enter configuration commands, one per line. End with CNTL/Z.
Ruijie(config)# ipv6 nd snooping stateless-user combine-security
```

show ipv6 nd snooping	ipv6 nd snooping

10.4(2)	

15.1.10 ipv6 nd snooping stateless-user address-bind

IPv6

no

```
ipv6 nd snooping stateless-user address-bind [strict] [ip-mac]
no ipv6 nd snooping stateless-user address-bind
```

strict	link-local link-local link-local
ip-mac	IP+MAC IP

```
Ruijie# configure terminal
Enter configuration commands, one per line. End with CNTL/Z.
Ruijie(config)# ipv6 nd snooping stateless-user address-bind
                2                               IP+MAC
Ruijie# configure terminal
Enter configuration commands, one per line. End with CNTL/Z.
Ruijie(config)#ipv6 nd snooping stateless-user address-bind strict
ip-mac
```

show ipv6 nd snooping

ipv6 nd snooping

Enter configuration commands, one per line. End with CNTL/Z.
Ruijie(config)# **ipv6 nd snooping stateless-user station-move**



show ipv6 nd snooping	ipv6 nd snooping
10.4(2)	

15.1.13 ipv6 nd snooping stateless-user per-vlan prefix-limit

VLAN IPv6

ipv6 nd snooping stateless-user per-vlan prefix-limit *num*
no ipv6 nd snooping stateless-user per-vlan prefix-limit

<i>num</i>	VLAN IPv6

2

VLAN 4 IPv6

Ruijie# **configure terminal**
 Enter configuration commands, one per line. End with CNTL/Z.
 Ruijie(config)#**ipv6 nd snooping stateless-user per-vlan prefix-limit 4**

show ipv6 nd snooping	ipv6 nd snooping
------------------------------	------------------

10.4(2)	
---------	--

15.1.14 clear ipv6 nd snooping key-node

clear ipv6 nd snooping key-node [vlan *vid*]

<i>vid</i>	VLAN

Ruijie# **clear ipv6 nd snooping key-node**

10.4(2)	

15.1.15 clear ipv6 nd snooping stateless-user

clear ipv6 nd snooping stateless-user [vlan *vid*]

<i>vid</i>	VLAN

```
Ruijie# clear ipv6 nd snooping stateless-user
```

10.4(2)	

15.1.16 clear ipv6 nd snooping prefix

VLAN

```
clear ipv6 nd snooping prefix [vid vlan]
```

<i>vlan</i>	VLAN

IPv6

```
Ruijie# clear ipv6 nd snooping prefix
```

--	--

--	--

|

10.4(2)	

15.2

15.2.1 show ipv6 nd snooping

IPv6 nd snooping

show ipv6 nd snooping [interface]

interface	

|

|

|

IPv6 nd snooping

Ruijie# **show ipv6 nd snooping**

--	--

15.2.2 show ipv6 nd snooping key-node

show ipv6 nd snooping key-node

|

|

|

Ruijie# **show ipv6 nd snooping key-node**

|

10.4(2)	

15.2.3 show ipv6 nd snooping stateless-user

```

    ipv6
    show ipv6 nd snooping stateless-user

```

```

```

```

```

```

```

```

    ipv6
    Ruijie# show ipv6 nd snooping stateless-user

```

```

```

10.4(2)	

15.2.4 show ipv6 nd snooping prefix

```

    show ipv6 nd snooping prefix

```

```

```

ND Snooping

16 MSTP

16.1

16.1.1 bpdu src-mac-check

bpdu mac

no

bpdu mac

bpdu src-mac-check *H.H.H*

no bpdu src-mac-check

<i>H.H.H</i>	mac	bpdu
no	bpdu	

┌

┌

┌

```
Ruijie(config)# interface gigabitethernet 1/1
Ruijie(config-if)# bpdu src-mac-check 00d0.f800.1e2f
```

-	-

┌

RSTP BPDU BPDU

clear spanning-tree detected-protocols [interface *interface-id*]

	<i>interface-id</i>	

|

|

|

|

Ruijie# **clear spanning-tree detected-protocols**

	show spanning-tree interface	STP

|

	-	-

16.1.3 spanning-tree

MSTP MSTP MSTP
no spanning-tree no
 spanning tree

spanning-tree [forward-time *seconds* | hello-time *seconds* | max-age *seconds*]

no spanning-tree [forwa Td[(no spannin)5(g)-10.001 Tc 0.0032 Tw 5.251 0 Td<01C4>Tj/TT1 1 Tf-0.000

forward-time hello-time max-age

$$2*(\text{Hello Time}+1.0\text{snd}) \leq \text{Max-Age Time} \leq 2*(\text{Forward-Delay}- 1.0\text{snd})$$

```

1 spanning-tree
Ruijie(config)# spanning-tree
2 BridgeForwardDelay
Ruijie(config)# spanning-tree forward-time 10

```

show spanning-tree	STP
spanning-tree mst cost	STP PathCost
spanning-tree tx-hold-count STP	TxHoldCount

-	-

16.1.4 spanning-tree autoedge

Autoedge disabled Autoedge

spanning-tree autoedge [disabled]

disabled	Autoedge

Ruijie(config)#

	-	-
--	---	---

16.1.6 spanning-tree bpduguard

	BPDU Guard	enabled	disabled
spanning-tree bpduguard [enable/disable]			
	enabled		EA 7
	disabled		BPDU Guard

Bä]xa ìÿ= Ã ðÀ % 3• Ð• HNBf9€ f"7Nf9€ v B NöhD†vc Nû4B ñ e%" 0CE I3L> xâ4Ãb3\ LN b2f"R C,

	-	-



root guard



16.1.14 spanning-tree mode

STP no

spanning-tree mode [stp | rstp | mstp]

no spanning-tree mode

stp	Spanning tree protocol(IEEE 802.1d)
rstp	Rapid spanning tree protocol(IEEE 802.1w)
mstp	Multiple spanning tree protocol(IEEE 802.1s)

MSTP

.

Ruijie(config)# **spanning-tree mode stp**

show spanning-tree	

-	-
---	---

```
VLAN 3 Instance 1 MST
Ruijie(config-mst)# no instance 1 vlan 3
Instance 1
Ruijie(config-mst)# no instance 1
MST show
```



MSTP

MSTP

Region

```
Instance 20 GigabitEthernet 1/1 10
Ruijie(config)# interface gigabitEthernet 1/1
Ruijie(config-if)# spanning-tree mst 20 port-priority 0
show spanning-tree mst instance interface interface-id
```

```
Instance 20                8192
Ruijie(config-if)# spanning-tree mst 20 priority 8192
show spanning-tree mst instance interface interface-id
```

	show spanning-tree interface	STP
	-	-

16.1.20 spanning-tree portfast

	Portfast	disabled	Portfast
	spanning-tree portfast [disabled]		
	disabled	Portfast	
	-		
	<pre>Ruijie(config)# interface gigabitethernet 1/1 Ruijie(config-if)# spanning-tree portfast</pre>		
	show spanning-tree interface	STP	
	-	-	

16.1.21 spanning-tree portfast bpdupfilter default

BPDU filter	no	BPDU filter
spanning-tree portfast bpdupfilter default		

no spanning-tree portfast bpdudfilter default

-	-

BPDU filter

BPDU Filter

BPDU

show spanning-treeRuijie(config)# **spanning-tree portfast bpdudfilter default**

show spanning-tree interface	STP

-	-

16.1.22 spanning-tree portfast bpduguard default

BPDU guard

no

BPDU guard

spanning-tree portfast bpduguard default**no spanning-tree portfast bpduguard default**

-	-

BPDU Guard.

```
Ruijie(config)# spanning-tree portfast bpduguard default
```

show spanning-tree interface	STP

-	-

16.1.23 spanning-tree portfast default

Portfast no Portfast

spanning-tree portfast default

no spanning-tree portfast default

-	-

Portfast

16.1.24 spanning-tree reset

	spanning-tree	no
	spanning-tree reset	
	-	-
	Ruijie(config)# spanning-tree reset	
	show spanning-tree	STP
	show spanning-tree interface	STP
	-	-

16.1.25 spanning-tree tc-guard

	tc-guard	no	tc-guard	tc-guard
	spanning-tree tc-guard			
	no spanning-tree tc-guard			
	-		-	
	tc-guard			

|

|

|

Ruijie(config-if)# **spanning-tree tc-guard**

|

-	-

|

|

-	-

16.1.26 spanning-tree tc-protection

tc- protection

no

tc- protection

spanning-tree tc- protection

no spanning-tree tc- protection

|

-	-

|

tc- protection

|

|

|

Ruijie(config)# **spanning-tree tc- protection**

|

-	-

|

-	-

16.1.27 spanning-tree tc-protection tc-guard

tc- guard no tc- guard tc-guard
tc

spanning-tree tc-protection tc-guard

no spanning-tree tc-protection tc-guard

-	-

tc- guard

Ruijie(config)# **spanning-tree tc-protection tc-guard**

-	-

-	-

16.1.28 spanning-tree tx-hold-count

STP TxHoldCount

MSTP

<i>tx-hold-count</i>	TxHoldCount	1	10

3



Ruijie(config)# **spanning-tree tx-hold-count 5**

show spanning-tree	MSTP	

tx-hold-count	TxHoldCount
pathcost method	

|

|

|

|

Ruijie# **show spanning-tree hello-time**



link-type	linktype
------------------	----------

┌

┌

┌

Ruijie# **show spanning-tree interface gigabitethernet 1/5**

spanning-tree bpdupfilter	BPDU filter
spanning-tree portfast	portfast
spanning-tree bpduguard	BPDU guard
spanning-tree link-type	“ ”

┌

-	-
---	---

16.2.3 show spanning-tree mst

MST Instance

show spanning-tree mst { **configuration** | *instance-id* [**interface** *interface-id*] }

configuration	mst
<i>instance-id</i>	<i>Instance</i>
<i>interface-id</i>	

Instance

.

Ruijie# **show spanning-tree mst configuration**



17 SPAN

17.1

17.1.1 monitor session

SPAN . no

monitor session *session_number* {**source interface** *interface-id* [**both** | **rx** | **tx**] |
destination interface *interface-id* **switch** | [**acl**

SPAN

|

|

|

show monitor

SPAN 1

```
Ruijie# show monitor session 1
sess-num: 1
src-intf:
GigabitEthernet 3/1 frame-type Both
dest-intf:
GigabitEthernet 3/8
```

|

monitor session	SPAN

|

|

-	-
---	---

18

```

1/2 //
Ruijie(config)# monitor session 2 destination remote vlan 7
interface gigabitEthernet 1/3 switch //
Ruijie(config)# monitor session 2 destination remote vlan 7
reflector-port interface gigabitEthernet 1/1 switch
2
Ruijie(config)# monitor session 2 remote-destination
Ruijie(config)# monitor session 2 destination remote vlan 7
interface gigabitEthernet 1/1 switch
    
```

show monitor	

reflector-port

-	-

18.1.2 remote-span

RSPAN VLAN

[no] remote-span

-	-

VLAN

end Ctrl+C
exit

```

Ruijie(config)# vlan 5
Ruijie(config)# remote-span
    
```

--	--

	show vlan	Vlan
	-	-

19 IP

19.1

19.1.1 ip address

IP

no

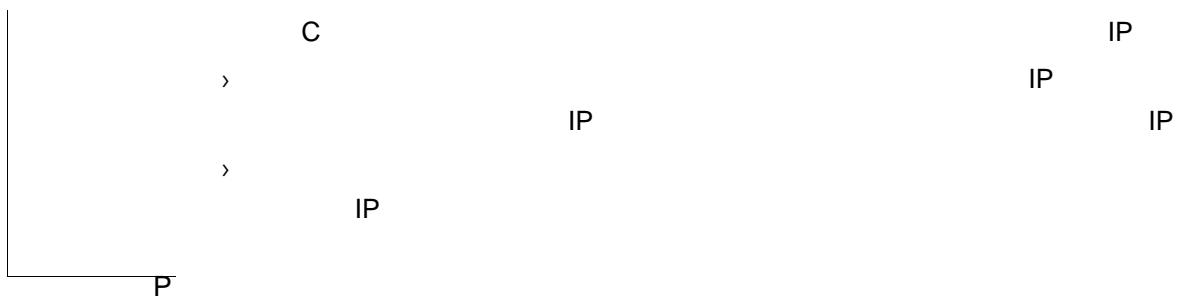

```
IP      10.10.10.1      255.255.255.0
ip address 10.10.10.1 255.255.255.0
```

show interface	

- >
- > SLIP HDLC PPP LAPB Frame-relay X.25
- > ping IP
- > SNMP
- >

|

ARP

|

RGOS

ARP

32

IP

48

MAC

ARP

ARP

clear

2

```
1          SVI 1          ARP
Ruijie(config)# interface vlan 1
Ruijie(config-if)# arp gratuitous-send interval 1

2          SVI 1          ARP
Ruijie(config)# interface vlan 1
Ruijie(config-if)# no arp gratuitous-send
```



IP

	Arp retry times <i>number</i>	ARP
--	--------------------------------------	-----

--

IP

	-	-
--	---	---

19.2.5 arp timeout

ARP

ARP

no

arp timeout *seconds*

no arp timeout

8192 ARP no
arp unresolve number
no arp unresolve

<i>number</i>	> ARP 8192	< 1-8192

ARP 8192

ARP

arp unresolved 500

-		-

-		-

19.2.7 ip proxy-arp

ARP ARP ip proxy-arp no
ip proxy-arp
no ip proxy-arp

-		-

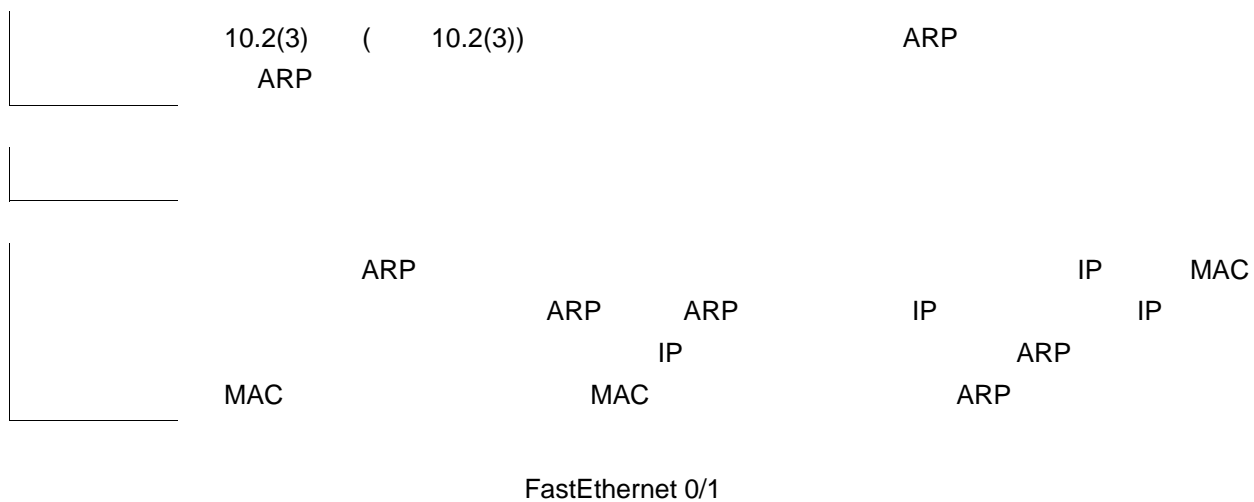

IP

mask

mask

ARP

vrf <i>vrf_name</i>	VRF	VRF	ARP
trusted	ARP	ARP	VRF
<i>ip</i>	IP trusted	IP	ARP ARP
<i>mask</i>	IP	ARP ;	trusted
static	ARP	ARP	
ARP <i>addre /b</i>		arp	

Age (min)	ARP
Hardware	IP
Type	ARPA
Interface	IP

2 show arp 192.168.195.68

Ruijie# show arp 192.168.195.68

```
Protocol Address Age(min) Hardware Type Interface
Internet 192.168.195.68 1 0013.20a5.7a5f arpa VLAN 1
```

3 show arp 192.168.195.0 255.255.255.0

Ruijie# show arp 192.168.195.0 255.255.255.0

```
Protocol Address Age(min) Hardware Type Interface
Internet 192.168.195.64 0 0018.8b7b.9106 arpa VLAN 1
Internet 192.168.195.2 1 00d0.f8ff.f00e arpa VLAN 1
Internet 192.168.195.5 -- 00d0.f822.33b1 arpa VLAN 1
Internet 192.168.195.1 0 00d0.f8a6.5af7 arpa VLAN 1
Internet 192.168.195.51 1 0018.8b82.8691 arpa VLAN 1
```

4 show arp 001a.a0b5.378d

Ruijie# show arp 001a.a0b5.378d

```
Protocol Address Age(min) Hardware Type Interface
Internet 192.168.195.67 4 001a.a0b5.378d arpa VLAN 1
```

-	-

-	-

19.3.3 show arp counter

ARP arp

show arp counter

--	--

-	-
---	---

--

--

--

```

show arp counter
Ruijie# show arp counter
The Arp Entry counter:0
The Unresolve Arp Entry:0
    
```

-	-
---	---

--

-	-
---	---

19.3.4 show arp detail

ARP

show arp detail [*interface-type interface-number*] *ip* [*mask*] | *mac-address* | **static** | **complete** | **incomplete**]

<i>interface-type interface-number</i>	ARP		
<i>ip</i>	ip	ip	ARP
<i>ip mask</i>	ip mask		ARP

ARP

ARP

show arp detail

Ruijie# **show arp detail**

IP Address	MAC Address	Type	Age(min)	Interface	Port
20.1.1.1	000f.e200.0001	Static	-- --	--	
20.1.1.1	000f.e200.0001	Static	-- VI3	--	
20.1.1.1	000f.e200.0001	Static	-- VI3	Gi2/0/1	
193.1.1.70	00e0.fe50.6503	Dynamic	1 VI3	Gi2/0/1	
192.168.0.1	0012.a990.2241	Dynamic	10 Gi2/0/3	Gi2/0/3	
192.168.0.1	0012.a990.2241	Dynamic	20 Ag1	Ag1	
192.168.0.1	0012.a990.2241	Dynamic	30 VI2	Ag2	
192.168.0.39	0012.a990.2241	Local	-- VI3	--	
192.168.0.39	0012.a990.2241	Local	-- Gi2/0/3	--	
192.168.0.1	0012.a990.2241	Local	-- VI3	--	
192.168.0.1	0012.a990.2241	Local	-- Gi2/3/2	--	

ARP

IP Address	IP
MAC Address	IP
Type	ARP
Age	ARP
Interface	IP
Port	ARP

	-	-

L

--	--	--

19.3.6 show ip arp

ARP

show ip arp

-	-

└───┘

└───┘

└───┘

show ip arp

Ruijie# **show ip arp**

```

Protocol Address      Age(min)Hardware      Type
Interface
Internet 192.168.7.233  23  0007.e9d9.0488  ARPA FastEthernet 0/0
Internet 192.168.7.112  10  0050.eb08.6617  ARPA FastEthernet 0/0
Internet 192.168.7.79   12  00d0.f808.3d5c  ARPA FastEthernet 0/0
Internet 192.168.7.1    50  00d0.f84e.1c7f  ARPA FastEthernet 0/0
Internet 192.168.7.215  36  00d0.f80d.1090  ARPA FastEthernet 0/0
Internet 192.168.7.127  0   0060.97bd.ebee  ARPA FastEthernet 0/0
Internet 192.168.7.195  57  0060.97bd.ef2d  ARPA FastEthernet 0/0
Internet 192.168.7.183  --  00d0.f8fb.108b  ARPA FastEthernet 0/0

```

ARP

Protocol	Internet
Address	IP
Age (min)	ARP “_”
Hardware	IP
Type	ARPA
Interface	IP

-	-

└───

-	-

19.3.7 show ip interface

IP

show ip interface [*interface-type interface-number*]

<i>Interface-type</i>	
<i>Interface-number</i>	

└───

└───

```

RGOS
          RGOS
          " UP"
          " UP"
          RGOS
  
```

```

show ip interface
Ruijie# show ip interface FastEthernet 0/1
IP interface state is: UP
IP interface type is: BROADCAST
IP interface metric is: 0
IP interface MTU is: 1500
IP address is:
192.168.5.133/24 (primary)
IP address negotiate is: OFF
  
```

Forward direct-boardcast is: ON
 ICMP mask reply is: ON
 Send ICMP redirect is: ON
 Send ICMP unreachableled is: ON
 DHCP relay is: OFF
 Fast switch is: ON
 Route horizontal-split is: ON
 Help address is: 0.0.0.0
 Proxy ARP is: ON
 Outgoing access list is not set.
 Inbound access list is not set.

IP interface state is:	"UP"
IP interface type is:	
IP interface MTU is:	MTU
IP address is:	IP
IP address negotiate is:	IP
Forward direct-boardcast is:	
ICMP mask reply is:	ICMP
Send ICMP redirect is:	ICMP
Send ICMP unreachableled is:	ICMP
DHCP relay is:	DHCP
Fast switch is:	IP
Route horizontal-split is:	
Help address is:	helper IP
Proxy ARP is:	ARP
Outgoing access list is	
Inbound access list is	

┌

┌

-	-

19.4

19.4.1 ip default-gateway

ip default-gateway no

ip default-gateway

no ip default-gateway

┌

-	-

┌

┌

┌

show ip redirects

┌

192.168.1.1
ip default-gateway 192.168.1.1

┌

show ip redirects	

┌

┌

-	-

20 DHCP Relay

20.1

20.1.1 ip dhcp relay check server-id

```
DHCP Relay check server-id no
DHCP Relay check server-id
```

[no] ip dhcp relay check server-id

-	-

└───┘

└───┘

DHCP Relay	DHCP	option server-id
DHCP		DHCP DHCP

```
Ruijie# configure terminal
Ruijie(config)# ip dhcp relay check server-id
```

Service dhcp	DHCP

└───┘

-	-

20.1.2 ip dhcp relay information option dot1x

DHCP Relay option dot1x no

[no] ip dhcp relay information option dot1x

-	-

|

|

|

DHCP

802.1x

DHCP

option dot1x

Ruijie# **configure terminal** 0xW& #H@ ! 'dip#"AF•\$8SG7N>RDF5DFsf"BDC>0D90f

ACL ACL ACE

dhcp option dot1x acl

```

Ruijie# configure terminal
Ruijie(config)# ip access-list extended
DenyAccessEachOtherOfUnauthrize
Ruijie(config-ext-nacl)# permit ip any host 192.168.3.1
//
Ruijie(config-ext-nacl)# permit ip any host 192.168.4.1
Ruijie(config-ext-nacl)# permit ip any host 192.168.5.1
Ruijie(config-ext-nacl)# permit ip host 192.168.3.1 any
// IP
Ruijie(config-ext-nacl)# permit ip host 192.168.4.1 any
Ruijie(config-ext-nacl)# permit ip host 192.168.5.1 any
Ruijie(config-ext-nacl)# deny ip 192.168.3.0 0.0.0.255 192.168.3.0
0.0.0.255
//
Ruijie(config-ext-nacl)# deny ip 192.168.3.0 0.0.0.255
192.168.4.0 0.0.0.255
Ruijie(config-ext-nacl)# deny ip 192.168.3.0 0.0.0.255
192.168.5.0 0.0.0.255
Ruijie(config-ext-nacl)# deny ip 192.168.4.0 0.0.0.255
192.168.4.0 0.0.0.255
Ruijie(config-ext-nacl)# deny ip 192.168.4.0 0.0.0.255
192.168.5.0 0.0.0.255
Ruijie(config-ext-nacl)# deny ip 192.168.5.0 0.0.0.255
192.168.5.0 0.0.0.255
Ruijie(config-ext-nacl)# deny ip 192.168.5.0 0.0.0.255
192.168.3.0 0.0.0.255
Ruijie(config-ext-nacl)# deny ip 192.168.5.0 0.0.0.255
192.168.4.0 0.0.0.255
Ruijie(config-ext-nacl)# exit
Ruijie(config)# ip dhcp relay information option dot1x access-group
DenyAccessEachOtherOfUnauthrize
    
```

service dhcp	DHCP

	ip dhcp relay information option dot1x	DHCP option dot1x
	-	-

20.1.4 ip dhcp relay information option82

DHCP Relay option82 no

[no] ip dhcp relay information option82

	-	-

option dot1x

DHCP option82

Ruijie# **configure terminal**

Ruijie(config)# **Ip dhcp relay information option82**

	Service dhcp	DHCP
	ip dhcp relay information option dot1x	DHCP option dot1x

	-	-

20.1.5 ip dhcp relay information option vpn

DHCP Relay

DHCP Relay Aware VRF

no



1		192.168.1.1
2	vrf	dep1

L

L

-	-

21 DNS

21.1

21.1.1 ip domain-lookup

	DNS	no	DNS
	ip domain-lookup		
	no ip domain-lookup		
	-		-
	DNS		
	DNS		DNS
	DNS		
	Ruijie(config)# ip domain-lookup		
	show hosts		DNS
	-		-

21.1.2 ip name-server

no IP/IPv6

	<i>ip-address</i>	IP
	no ip host host-name ip-address	
	Ruijie(config)# ip host switch 192.168.5.243	
	show hosts	DNS
	-	-

21.1.4 ipv6 host

	IPV6	no
	ipv6 host <i>host-name ipv6-address</i>	
	no ipv6 host <i>host-name ipv6-address</i>	
	<i>host-name</i>	
	<i>ipv6-address</i>	IPV6
	no ipv6 host host-name ipv6-address	
	Ruijie(config)# ipv6 host ruijie 2001:0DB8:700:20:1::12	

show hosts	DNS

|

-	-

21.2

21.2.1 clear host

clear host [*host-name*]

<i>host-name</i>	{ * }

|

|

2 DNS	1 ip host ipv6 host DNS

|

-IP

clear host *

show hosts	

|

-	-

21.2.2 show hosts

DNS

show hosts [*hostname*]

-	-

└───┘

└───┘

└───┘

DNS

Ruijie# **show hosts**

Name servers are:

static

host	type	address
switch	static	192.168.5.243
www.ruijie.com	dynamic	192.168.5.123

└───┘

ip host	IP
ipv6 host	IPV6
ip name-server	DNS

└───┘

└───┘

-	-

22 SNTP

22.1

22.1.1 sntp enable

	SNTP	no	—Disable
[no] sntp enable			
	-	-	
	SNTP	Disable	
	show sntp	SNTP	
	Ruijie(config)# sntp enable		

|
|

|

show sntp SNTP

|

Ruijie(config)# **sntp server** 192.168.4.12

|

--	--

show sntp

SNTP

|

SNTP

SNTP sync interval : 60
Time zone : +8

sntp enable	SNTP
show sntp	SNTP

RGOS10.0

-	-

ntp access-group { **peer** | **serve** | **serve-only** | **query-only** } *access-list-number* | *access-list-name*

no ntp access-group{**peer** | **serve** | **serve-only** | **query-only**}*access-list-number* | *access-list-name*

peer	NTP
serve	NTP
serve-only	NTP
query-only	NTP
<i>access-list-number</i>	IP 1 99 1300 1999
<i>access-list-name</i>	IP

NTP

NTP
NTP
NTP

peer serve serve-only query-only



1
2

Ruijie(config)# **ntp access-group peer 1**

Ruijie(config)# **ntp access-group serve-only 2**

ip access-list	IP

	-	-

23.1.3 ntp authenticate

NTP NTP

ntp authenticate

no ntp authenticate

	-	-

NTP

ntp authentication-key ntp trusted-key

```

ntp authentication-key 6 md5 woooooop
ntp trusted-key 6
ntp authenticate
    
```

	ntp authentication-key	
	ntp trusted-key	

	-	-

23.1.4 ntp authentication-key

NTP

NTP

ntp authentication-key *key-id* **md5** *key-string* [*enc-type*]

no ntp authentication-key *key-id* **md5** *key-string* [*enc-type*]

<i>key-id</i>	ID
<i>key-string</i>	
<i>enc-type</i>	0

NTP

	-	-
--	---	---

<1879153861C4]T/T1 1 Tf-2.9940 Td()TET60.84 7404.5 0.24 20.43 ref66.84 7404.5 063.2 0 24

└───┘

└───┘

20

prefer

NTP

IP

NTP

└───┘

NTP server

IPv4 Ruijie(config)# **ntp server** 192.168.210.222

IPv6 Ruijie(config)# **ntp server** 10::2

└───┘

no ntp	NTP

└───┘

└───┘

-	-

23.1.8 ntp synchronize

NTP

ntp synchronize

no ntp synchronize

└───┘

-	-

└───┘

└───┘

NTP

┌

┌

NTP

Ntp synchronize

┌

ntp server	NTP

┌

┌

-	-

23.1.9 ntp trusted-key

ID

ntp trusted-key *key-id*

no ntp trusted-key *key-id*

┌

<i>key-id</i>	ID

┌

┌

┌

NTP

ID

┌

```
ntp authentication-key 6 md5 woooooop
ntp trusted-key 6
ntp server 192.168.210.222 key 6
```

┌

--	--

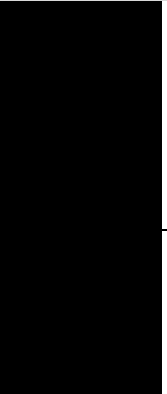
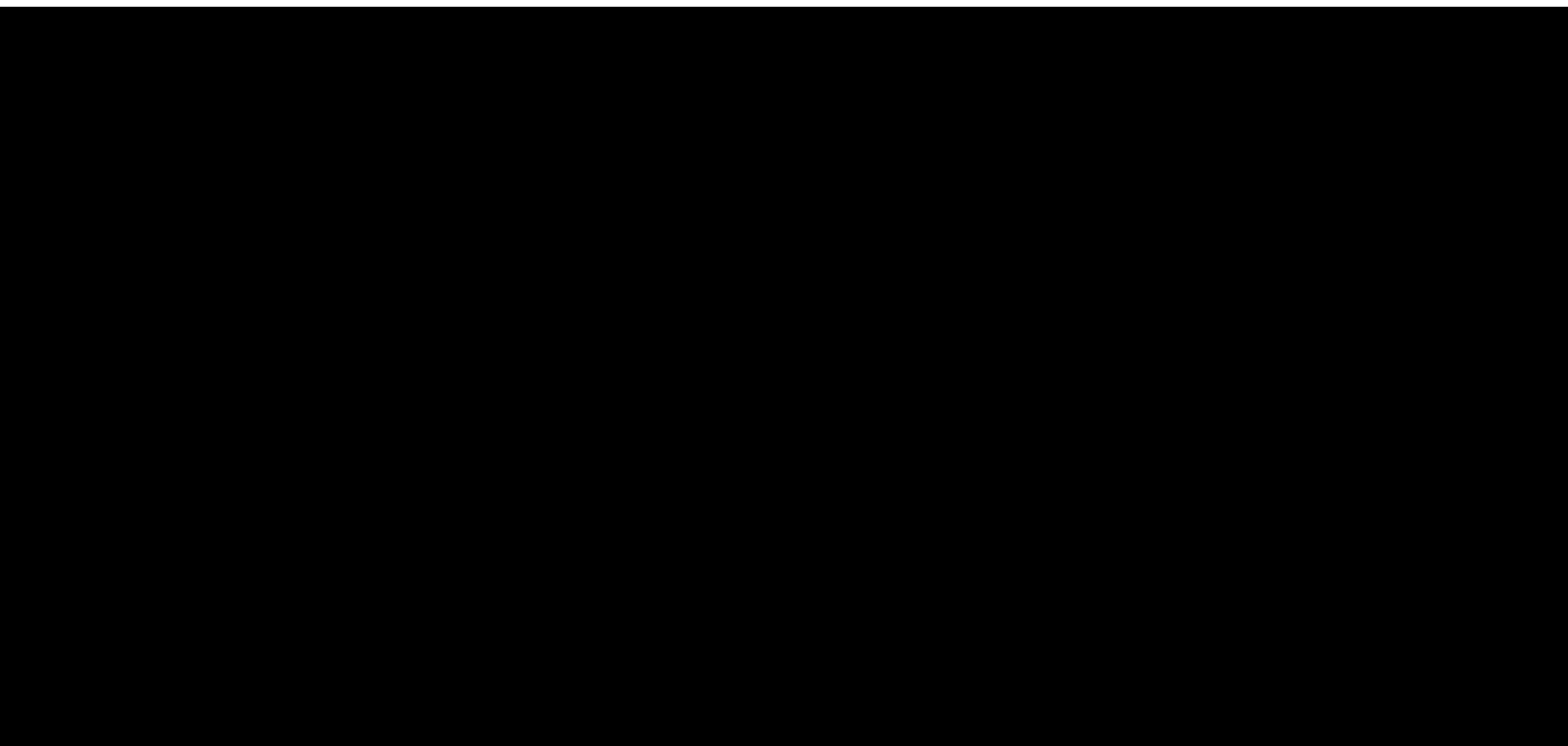

NTP

	-	-

|

|

|

NTP

NTP

|

NTP

show ntp status

	-	-

|

	-	-

24 FTP Server

24.1

24.1.1 debug ftpserver

FTP

no

debug ftpserver

no debug ftpserver



FTP Server

-	-
---	---

24.1.2 ftp-server enable

FTP no FTP

ftp-server enable

no ftp-server enable

-	-

--

--

FTP	FTP
	ftp-server topdir
FTP	FTP

1 FTP syslog

ftp-server password [*type*] *password*

no ftp-server password

<i>type</i>	0 7 0
<i>password</i>	7

┌

┌

FTP

	1	25	4
	52		
⚡	FTP		

```

1 pass
Ruijie(config)# ftp-server password pass

Ruijie(config)# ftp-server password 0 pass
2 8001
Ruijie(config)# ftp-server password 7 8001
3
Ruijie(config)# no ftp-server password
    
```

-	-

┌

-	-

24.1.4 ftp-server topdir

FTP

no

FTP

ftp-server topdir *directory*

no ftp-server topdir

<i>directory</i>	FTP

FTP

FTP

```
>
>
>
>
>
>
>
>
```

FTP

```
Ruijie# show ftp-server
ftp-server information
=====
enable : Y
topdir : /
timeout: 20min
username config : Y
password config : Y
type: BINARY
control connect : Y
ftp-server: ip=192.167.201.245 port=21
ftp-client: ip=192.167.201.82 port=4978
port data connect : Y
ftp-server: ip=192.167.201.245 port=22
ftp-client: ip=192.167.201.82 port=4982
passive data connect : N
```

-	-

SNMP

SNMP

no snmp

123456:

over chassis-id 123456

	SNMP

<i>aclnumber</i>	1-99 MIB ipv4 NMS
<i>aclname</i>	MIB ipv4 NMS
<i>ipv6_aclname</i>	ipv6 MIB

<i>text</i>	

└──

└──

└──

SNMP

i-net800@i-net.com.cn

Ruijie(config)# snmp-server community G6t6t"0@hgG2F-D

	<i>ipv6_aclname</i>	ipv6 MIB ipv6 NMS
--	---------------------	-------------------------

<i>port-num</i>	snmp
<i>notification-type</i>	snmp

┌

SNMP

┌

┌

snmp-server enable traps

NMS

SNMP

vrf

[

vrf

]

┌

SNMP

SNMP

Ruijie(config)# **snmp-server host 192.168.12.219 public snmp**

┌

snmp-server enable traps	

┌

┌

-	-

25.1.8 snmp-server location

SNMP

snmp-server location

no

SNMP

snmp-server location *text*

no snmp-server location

┌

<i>text</i>	

┌

|

|

|

Ruijie(config)# **snmp-server location** start-technology-city 4F of A Buliding

|

snmp-sever contact	SNMP

|

|

-	-

25.1.9 snmp-server packetsiz

SNMP

snmp-sever packetsize

no

snmp-server packetsize *byte-count*

no snmp-server packetsize

|

<i>byte-count</i>	484 17876

|

1500

|

|

|

SNMP

1492

Ruijie(config)# **snmp-server packetsize** 1492

|

--	--

	snmp-server queue-length	SNMP
--	---------------------------------	------

--

	-	-

SNMP

no

SNMP

snmp-server system-shutdown

snmp-server system-shutdown

no snmp-server system-shutdown

-	-

SNMP

SNMP

RGOS

reload/reboot

NMS

SNMP

Ruijie(config)# **snmp-server system-shutdown**

-	-

-	-

25.1.12 snmp-server trap-source

SNMP

snmp-server trap-source

no

snmp-server trap-source *interface*

no snmp-server trap-source

<i>interface</i>	SNMP

SNMP

IP

┌

┌

SNMP

IP
IP SNMP

┌

0 IP SNMP

Ruijie(config)# **snmp-server trap-source fastethernet 0**

┌

snmp-server enable traps	
snmp-server enable host	NMS

┌

┌

-	-

25.1.13 snmp-server trap-timeout

snmp-server trap-timeout

no

snmp-server trap-timeout *seconds*

no snmp-server trap-timeout

┌

seconds	1 – 1000

┌

30

┌

┌

┌

60

Ruijie(config)# **snmp-server trap-timeout 60**

snmp-server queue-length	
snmp-server enable host	NMS

-	-

25.1.14 snmp-server user

SNMP **snmp-server user** no

snmp-server user *username groupname* {**v1** | **v2** | **v3** [**encrypted**] [**auth** {**md5** | **sha**} *auth-password*] [**priv** **des56** *priv-password*]}[**access** {[**ipv6** **ipv6_aclname**] [**aclnum** | **aclname**]}]

no snmp-server user *username groupname* {**v1** | **v2c** | **v3** }

<i>username</i>			
<i>groupname</i>			
v1 v2 v3	SNMP	v3	
encrypted	16	SHA	MD5 16
auth			20

SHA

<i>aclnum</i>	MIB ipv4 NMS
<i>aclname</i>	MIB ipv4 NMS
<i>ipv6_aclname</i>	ipv6 MIB ipv6 NMS

└──

└──

└──

```

                                snmpV3          md5          DES
Ruijie(config)# snmp-server user user-2 mib2user v3 auth md5
authpassstr priv des56 despassstr
    
```

show snmp user	SNMP

└──

-	-

25.1.15 snmp-server view

SNMP

snmp-server view

s

n

┌

default

MIB

┌

┌

┌
Ruijie(config)#

MIB-2 oid 1.3.6.1

snmp-server view mib2 1.3.6.1 include

┌
└

show snmp view	SNMP

┌

┌
└

-	-

25.1.16 snmp trap link-status

25.2

25.2.1 show snmp

SNMP

show snmp

show snmp [mib | user | view | group| host]

┌
└

-	-

┌

┌

┌

show snmp

SNMP

```

show snmp mib                snmp mib
show snmp user             snmp
show snmp view            snmp
show snmp group          snmp
show snmp host

```

SNMP

```

Ruijie# show snmp
Chassis: 60FF60
0 SNMP packets input
0 Bad SNMP version errors
0 Unknown community name
0 Illegal operation for community name supplied
0 Encoding errors
0 Number of requested variables
0 Number of altered variables
0 Get-request PDUs
0 Get-next PDUs
0 Set-request PDUs
0 SNMP packets output
0 Too big errors (Maximum packet size 1500)
0 No such name errors
0 Bad values errors
0 General errors
0 Response PDUs
0 Trap PDUs
SNMP global trap: disabled
SNMP logging: disabled
SNMP agent: enabled

```

snmp-server chassis-id	SNMP

-	-

26 RMON

26.1

26.1.1 rmon alarm

MIB no

rmon alarm *number variable interval {absolute | delta } rising-threshold value [event-number] falling-threshold value [event-number] [owner ownname]*

no rmon alarm *number*

-	-

└──

└──

RGOS variable
 absolute/delta owner interval rising-threshold/falling-threshold event

MIB ifInNUcastPkts.6
 Ruijie(config)# **rmon alarm** 10 1.3.6.1.2.1.2.2.1.12.6 30 **delta**
rising-threshold 20 1 **falling-threshold** 10 1 **owner** zhangsan

rmon event <i>number [log] [trap community] [description-string]</i>	

└──

-	-

26.1.2 rmon collection history

no

rmon collection history *index* [**owner** *ownername*] [**buckets** *bucket-number*] [**interval** *seconds*]

no rmon collection history *index*



	-	-

|

|



trap

Ruijie(config)# **rmon event**

Event type : log-and-trap
Community : public
Last time sent : 0d:0h:0m:0s
Owner : zhangsan
Log : 1
Log time : 0d:0h:37m:47s

```
Ruijie# show rmon event
Alarm : 1
Interval : 1
Variable : 1.3.6.1.2.1.4.2.0
Sample type : absolute
Last value : 64
Startup alarm : 3
Rising threshold : 10
Falling threshold : 22
Rising event : 0
Falling event : 0
Owner : zhangsan
```

--	--

rmon event *number* [**log**] [

```

Ruijie# show rmon history
Entry : 1
Data source : Gil/1
Buckets requested : 65535
Buckets granted : 10
Interval : 1
Owner : zhangsan
Sample : 198
Interval start : 0d:0h:15m:0s
DropEvents : 0
Octets : 67988
Pkts : 726
BroadcastPkts : 502
MulticastPkts : 189
CRCAlignErrors : 0
UndersizePkts : 0
OversizePkts : 0
Fragments : 0
Jabbers : 0
Collisions : 0
Utilization : 0
    
```

rmon collection history <i>index</i> [owner <i>ownername</i>] [buckets <i>bucket-number</i>] [interval <i>seconds</i>]	

--	--

-	-

Ruijie# **show rmon statistics**

```

Statistics : 1
Data source : Gil/1
DropEvents : 0
Octets : 1884085
Pkts : 3096
BroadcastPkts : 161
MulticastPkts : 97
CRCAlignErrors : 0
UndersizePkts : 0
OversizePkts : 1200
Fragments : 0
Jabbers : 0
Collisions : 0
Pkts64Octets : 128
Pkts65to127Octets : 336
Pkts128to255Octets : 229
Pkts256to511Octets : 3
Pkts512to1023Octets : 0
Pkts1024to1518Octets : 1200
Owner : zhangsan
    
```

rmon collection stats <i>index</i> [owner <i>owner-string</i>]	

	-	-

27 IPv6

27.1

27.1.1 ping ipv6

IPV6

ping ipv6 [ipv6-address]

ipv6-addres	s

└───┘

└───┘

└───┘

└───┘

Ruijie# ping ipv6 fec0::1

ping

!	
.	
U	
R	
F	
A	
D	Down IPV6 ()
?	

└───┘

-	-

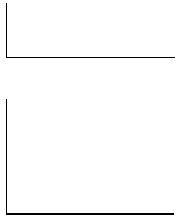

-	-

27.1.2 ipv6 address

IPV6 , no

ipv6 address *ipv6-address/prefix-length*

ipv6 address *ipv6-prefix/prefix-length eui-64*

ipv6 address *prefix-name sub-bits/prefix-length [eui-64]*

no ipv6 address

no ipv6 address *ipv6-address/prefix-length*

no ipv6 address *ipv6-prefix/prefix-length eui-64*

no ipv6 address *prefix-name sub-bits/prefix-length [eui-64]*



<i>ipv6-address</i>	IPV6 RFC4291 16
<i>ipv6-prefix</i>	IPV6 RFC4291 16
<i>prefix-length</i>	IPV6 IPV6
<i>prefix-name</i>	
<i>sub-bits</i>	RFC4291
eui-64	IPV6 64 ID



IPV6	UP
IPv6	IPv6 = " " +
" " + "	ipv6 general-prefix
DHCPv6 PD	" DHCPv6 " "
" + "	<i>sub-bits/prefix-length</i>
no ipv6 address	

|



default

2	IPv6	ipv6 enable
	IPv6	
	IPv6	IPv6
	no ipv6 enable	IPV6

Ruijie(config-if)# **ipv6 enable**

show ipv6 interface	
----------------------------	--

-	-
---	---

27.1.5 ipv6 general-prefix

IPv6

ipv6 general-prefix

ipv6 general-prefix *prefix-name ipv6-prefix/prefix-length*

no ipv6 general-prefix *prefix-name ipv6-prefix/prefix-length*

<i>prefix-name</i>	
<i>ipv6-prefix</i>	RFC4291
<i>prefix-length</i>	

IPv6

my-prefix

Ruijie(config)# **ipv6 general-prefix** my-prefix 2001:1111:2222::/48

ipv6 address prefix-name	
sub-bits/prefix-length	
show ipv6 general-prefix	

RGOS10.4	RGOS10.4

27.1.6 ipv6 hop-limit

ipv6 hop-limit value

no ipv6 hop-limit

-	-

64

Ruijie(config)# **ipv6 hop-limit** 100

--	--

	-	-
	-	-

27.1.7 ipv6 nd dad attempts

```

                IPV6                                (NS)
                no
    ipv6 nd dad attempts value
    no ipv6 nd dad attempts
    
```

value	(NS)	0
	0-600	ipv6 :

```

1

```

```

                IPV6
                "tentative"( )
                EUI-64
                (                IPV6                )
                down/up
                down                up
    
```

```

Ruijie(config)# interface vlan 1
Ruijie(config-if)# ipv6 nd dad attempts 3
    
```

show ipv6 interface	

no

ipv6 neighbor *ipv6-address interface-id hardware-address*

no ipv6 neighbor *ipv6-address interface-id*

<i>ipv6-address</i>	IPV6	RFC4291
<i>interface-id</i>	SVI	Routed Port,L3 AP
<i>hardware-address</i>	MAC	XXXX.XXXX.XXXX 48 'X'

ARP

IPV6

NDP

Reachble

IPV6

IPV6

mac

inactive

show ipv6 neighbor static

clear ipv6 neighbors

(NDP)

show ipv6 neighbors

Ruijie(conifg)#

ipv6 neighbor 2001::1 vlan 1 00d0.f811.1111

show ipv6 neighbors	
clear ipv6 neighbors	

-	-
---	---

27.1.10 ipv6 ns-linklocal-src

" no ipv6
IPv6

ns-linklocal-src
RFC3484

ipv6 ns-linklocal-src

no ipv6 ns-linklocal-src

-	-

|

|

|

|

Ruijie(config)# no ipv6 ns-linklocal-src

-	-

|

-	-

27.1.11 ipv6 route

IPV6

no

ipv6 route *ipv6-prefix/prefix-length* {*ipv6-address* | *interface-id* [*ipv6-address*]}

no ipv6 route *ipv6-prefix/prefix-length* {*ipv6-address* | *interface-id* [*ipv6-address*]}

<i>ipv6-prefix</i>	IPV6 RFC4291
<i>prefix-length</i>	IPV6 '/'

<i>ipv6-address</i>	RFC4291
<i>interface-id</i>	

┌

┌

⚡

┌

Ruijie(config)# **ipv6 route 2001::/64 vlan 1 2005::1**

┌

show ipv6 route	IPv6

┌

-	-

27.1.12 ipv6 source-route

	IPv6	no
IPv6		
ipv6 source-route		
no ipv6 source-route		

	-	-

|

IPv6

|

|

0

IPv6

0

IPv6

|

Ruijie(config)# **no ipv6 source-route**

|

	-	-

27.2

27.2.1 clear ipv6 neighbors

clear ipv6 neighbors

	-	-

┌

┌

┌

┌

Ruijie# **clear ipv6 neighbors**

	ipv6 neighbor	
	show ipv6 neighbors	

┌

	-	-

27.2.2 show ipv6 general-prefix

show ipv6 general-prefix

show ipv6 general-prefix

	-	-

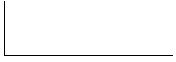

```

Ruijie# show ipv6 interface vlan 1
Interface vlan 1 is Up, ifindex: 2001
address(es):
Mac Address: 00:00:00:00:00:01
INET6: fe80::200:ff:fe00:1 , subnet is fe80::/64
INET6: 2001::1 , subnet is 2001::/64 [TENTATIVE]
Joined group address(es):
ff01:1::1
ff02:1::1
ff02:1::2
ff02:1::1:ff00:1
MTU is 1500 bytes
ICMP error messages limited to one every 10 milliseconds
ICMP redirects are enabled
ND DAD is enabled, number of DAD attempts: 1
ND reachable time is 30000 milliseconds
ND advertised reachable time is 0 milliseconds
ND retransmit interval is 1000 milliseconds
ND advertised retransmit interval is 0 milliseconds
ND router advertisements are sent every 200 seconds<240--160>
ND router advertisements live for 1800 seconds

```

INET6: 2001::1 , subnet is 2001::/64

[TENTATIVE]	INET6	[]
ANYCAST		
TENTATIVE		(DAD)
DUPLICATED		
DEPRECATED		
NODAD		
AUTOIFID		EUI-64
PRE		
GEN		

```
Ruijie# show ipv6 interface vlan 1 ra-info
```

vlan 1: DOWN

total	
fec0:1:1:1::/64	
Def	
Auto CFG	Auto IPV6 , CFG
!Adv	
vtime	()
ptime	()
L !L	L !L on-link
A !A	A

1 SVI 1

Ruijie# **show ipv6 neighbors vlan 1**

```
IPv6 Address Linklayer Addr Interface
fa::1          00d0.0000.0002 vlan 1
fe80::200:ff:fe00:2 00d0.0000.0002 vlan 1
```

2

Ruijie# **show ipv6 neighbors verbose**

```
IPv6 Address Linklayer Addr Interface
2001::1       00d0.f800.0001 vlan 1
                State: Reach/H Age: - asked: 0
fe80::200:ff:fe00:1 00d0.f800.0001 vlan 1
                State: Reach/H Age: - asked: 0
```

IPv6 Address	IPV6
Linklayer Addr	Mac incomplete
Interface	

```

state/H(R)
STATE
INCMP( Incomplete)—
      (NS)
      (NA)
REACH(Reachable) —

      STALE —

NUD
( Neighbor Unreachability Detection )
DELAY—          STALE
                STALE    DELAY
State           DELAY_FIRST_PROBE_TIME seconds(5  )

      DELAY      PROBE
                (NS)      NUD
PROBE—      NUD
      RetransTimer milliseconds
      (NS)

MAX_UNICAST_SOLICIT(3  )
?—
/R—

```

Interface

G Q,Á/P Yb Q V@ldr Q)b Sc“hG /Q`Ab •a-a ðÀ R T

show ipv6 router

IPv6

Ruijie# **show ipv6 router**

Router FE80::2D0:F8FF:FEC1:C6E1 on VLAN 2, last update 62 sec
Hops 64, Lifetime 1800 sec, ManagedFlag=0, OtherFlag=0, MTU=1500
Preference=MEDIUM
Reachable time 0 msec, Retransmit time 0 msec
Prefix 6001:3::/64 onlink autoconfig
Valid lifetime 2592000 sec, preferred lifetime 604800 sec
Prefix 6001:2::/64 onlink autoconfig
Valid lifetime 2592000 sec, preferred lifetime 604800 sec

-	-



28 MLD Snooping

28.1

28.1.1 ipv6 mld profile

MLD profile profile profile-number mld
profile

	10.4	

28.1.3 deny

	profile	profile	deny
	deny		
	profile	deny	
	profile		
	profile	range	
		FF77::100	profile :
	Ruijie(config)# ipv6 mld profile 1		
	Ruijie(config-profile)# range FF77::100		
	Ruijie(config-profile)# deny		
	ipv6 mld profile	profile	
	range		
	permit	profile	permit
	10.4		

28.1.4 permit

	profile	profile	permit
	permit		

┌

┌

┌

┌

┌

VLAN

VLAN

VLAN

mld snooping ivgl

Ruijie(config)# **ipv6 mld snooping ivgl**

ipv6 mld snooping svgl	mld snooping svgl
ipv6 mld snooping ivgl-svgl	mld snooping

10.4	

28.1.6 ipv6 mld snooping svgl profile

SVGL

snooping profile *profile-number*, no ipv6 mld snooping profile

ipv6 mld snooping profile *profile-number*

no ipv6 mld snooping profile

<i>profile-number</i>	profile 1-1024

┌

┌

┌

mld snooping

mld snooping SVGL

SVGL profile

SVGL

profile

SVGL

SVGL

IVGL-SVGL

SVGL

VLAN

VLAN

SVGL

┌

┌

10.4	

28.1.8 ipv6 mld snooping query-max-response-time

ipv6 mld snooping query-max-response-time *time* MLD
no ipv6 mld snooping query-max-response-time

ipv6 mld snooping query-max-response-time *time*
no ipv6 mld snooping query-max-response-time

┌

<i>time</i>	MLD 1-65535

┌

10s

┌

┌

MLD

0

mld snooping

MLD

0

mld snooping

MLD

┌

MLD

15s

Ruijie(config)# **ipv6 mld snooping query-max-response-time 15**

┌

--	--

	10.4	
--	------	--

28.1.9 ipv6 mld snooping vlan

ipv6 mld snooping vlan vid vlan mld snooping **no ipv6**
mld snooping vlan vid vlan mld snooping
ipv6 mld snooping vlan vid
no ipv6 mld snooping vlan vid

<i>vid</i>	vlan id 1-4094

mld snooping vlan mld snooping

mld snooping vlan mld snooping

vlan mld snooping

VLAN 1 mld snooping

Ruijie(config)# **no ipv6 mld snooping vlan 1**

10.4	

28.1.10 ipv6 mld snooping vlan mrouter learn

MLD query PIM

ipv6 mld snooping vlan mrouter learn no

ipv6 mld snooping vlan vid mrouter learn
no ipv6 mld snooping vlan vid mrouter learn

MLD Snooping

┌

┌

10.4	

28.1.15 ipv6 mld source-check port

```
no mld snooping
   ipv6 mld snooping source-check port
```

```
ipv6 mld snooping source-check port
no ipv6 mld snooping source-check port
```

┌

┌

┌

┌

```
mld snooping          MLD          mld snooping
                       mld snooping
```

┌

```
           mld snooping
Ruijie(config)# ipv6 mld snooping source-check port
```

┌

,	,

┌

10.4	

28.1.16 ipv6 mld snooping filter

profile no profile

ipv6 mld snooping filter *profile-number*

no ipv6 mld snooping filter *profile-number*

<i>profile-num</i>	profile

└──

└──

MLD Profile	MLD Report
	MLD Profile
	profile filter

0/1 profile 1

```
Ruijie(config)# interface fastEthernet 0/1
Ruijie(config-if)# ipv6 mld snooping filter 1
```

ipv6 mld profile	profile

ipv6 mld

snooping max-groups no

ipv6 mld snooping max-groups *number*

no ipv6 mld snooping max-groups

<i>Number</i>	0 – 1024

1024

MLD Report

0/1 100

Ruijie(config)# interface fastEthernet 0/1

Ruijie(config-if)# ipv6 mld snooping max-group 100

ipv6 mld snooping filter	

10.4	

28.1.18 clear ipv6 mld snooping gda-table

clear ipv6 mld snooping

gda-table

clear ipv6 mld snooping gda-table

|

|

|

Ruijie# **clear ipv6 mld snooping gda-table**

|

|

|

10.4	

28.1.19 debug mld-snp

mld

,

debug mld-snp

10.4	

28.2

28.2.1 show ipv6 mld snooping

mld snooping

Show ipv6 mld snooping [gda-table | interfaces | mrouter/ statistics [vlan *vlan-id*]

	mld snooping
gda-table	
interfaces	mld snooping Filtering
mrouter	
statistics [vlan <i>vlan-id</i>]	snooping

mld snooping

```

1      show ipv6 mld snooping          mld snooping
Ruijie# show ipv6 mld snooping
MLD-snooping mode      : IVGL
SVGL vlan-id           : 1
SVGL profile number    : 0
Source check port      : Disabled
Query max response time : 10(Seconds)
2      show ipv6 mld snooping statistics  mld snooping

Ruijie# show ipv6 mld snooping statistics
GROUP   Interface   Last report      Last leave      Last
                time         time            reporter

```

```

-----
FF88::1 VL1:Gi4/2 0d:0h:0m:7s ---- 2003::1111
Report pkts: 1 Leave pkts: 0
3 show ipv6 mld snooping mrouter mld snooping

```

```

Ruijie# show ipv6 mld snooping mrouter
Vlan Interface State MLD profile number
----
1 GigabitEthernet 0/7 static 1
1 GigabitEthernet 0/12 dynamic 0
4 show ipv6 mld snooping gda-table GDA

```

```

Ruijie# show ipv6 mld snooping gda-table
Abbr: M - mrouter
      D - dynamic
      S - static
VLAN Address Member ports
-----
1 FF88::1 GigabitEthernet 0/7(S)
5 show ipv6 mld snooping interface mld snooping Filtering

```

```

Ruijie# show ipv6 mld snooping interface GigabitEthernet 0/7
Interface Filter Profile number max-groups
-----
GigabitEthernet 0/7 1 4294967294

```

10.4	

28.2.2 show ipv6 mld profile

MLD profile

show ipv6 mld profile [*profile-number*]

	profile
<i>profile-number</i>	profile

mld profile

```
1      show ipv6 mld profile      MLD profile
Ruijie# show ipv6 mld profile 1
MLD Profile 1
permit
range FF77::1 FF77::100
range FF88::123
```

29

29.1

29.1.1 storm-control

no

storm-control {**broadcast** | **multicast** | **unicast**} [{**level** *percent* | **pps** *packets* | *rate-bps*}]

no storm-control {**broadcast** | **multicast** | **unicast**} [{**level** *percent* | **pps** *packets* | *rate-bps*}]

broadcast	
multicast	
unicast	
<i>percent</i>	20 20%
<i>packets</i>	pps packets per second
<i>Rate-bps</i>	
<i>64k-2M</i>	64k
<i>2-100M</i>	1M
<i>100M</i>	8M

show storm-control

GigabitEthernet 1/1

4M

Ruijie# **configure terminal**

Ruijie(config)# **interface GigabitEthernet 1/1**

Ruijie(config-if)# **storm-control multicast 4096**

Ruijie(config-if)# **end**

show storm-control	

86 **pps**

-	-

29.1.2 switchport protected

no

switchport protected

no switchport protected

-	-

3

show interfaces

Ruijie(config)# **interface gigabitethernet 1/1**

Ruijie(config-if)# **switchport protected**

show interfaces	

|

-

|

-	-

29.1.3 switchport port-security

no

switchport port-security [violation {protect | restrict | shutdown}]

no switchport port-security [violation]

|

port-security	
violation protect	
violation restrict	trap
violation shutdown	Trap

|

|

|

```

)
(
MAC
IP(
)
1
M

```

|

```

GigabitEthernet 1/1
shutdown
Ruijie(config)# interface gigabitEthernet 1/1
Ruijie(config-if)# switchport port-security
Ruijie(config-if)# switchport port-security violation shutdown

```

|

--	--

show port-security

	show port-security	
--	---------------------------	--

--	--	--

switchport port-security	
switchport port-security binding interface	
Switchport port-security mac-address	
switchport port-security aging	
show port-security	

-	-

29.1.6 switchport port-security binding interface

IP+ MAC IP

no

[no] switchport port-security binding interface *interface-id* *mac-address* **vlan** *vlan_id* *ipv4-address* | *ipv6-address*

[no] switchport port-security binding interface *interface-id* *ipv4-address* | *ipv6-address*

<i>interface-id</i>	ID
<i>mac-address</i>	MAC
<i>Vlan_id</i>	MAC VID
<i>Ipv4-address</i>	Ipv4 Ip
<i>Ipv6-address</i>	Ipv6 Ip

```

1      192.168.1.100      10
Ruijie(config)# switchport port-security binding interface g0/10
192.168.1.100
2      192.168.1.100 MAC      00d0.f800.5555, VID= 1      10
Ruijie(config)# switchport port-security binding interface g0/10 00d0.f800.5555
vlan 1 192.168.1.100

```

	switchport port-security	
	switchport port-security binding	
	Switchport port-security mac-address	
	switchport port-security aging	
	show port-security	

1 TRUNK 10

```
1 TRUNK 10 00d0.f800.5555 VID=2
Ruijie(config)# switchport port-security interface g0/10
mac-address 00d0.f800.5555 vlan 2
```

	switchport port-security	
	switchport port-security aging	
	switchport port-security mac-address	

	-	-

30 802.1X

30.1 dot1x

30.1.1 dot1x auto-req

802.1X

dot1x auto-req

no

[no] dot1x auto-req

-	-

└───

└───

└───

802.1x

show dot1x auto-req

└───

802.1x

```

Ruijie# configure terminal
Ruijie(config)# dot1x auto-req
Ruijie(config)# end
Ruijie# show dot1x auto-req
Ruijie(config)# dot1x auto-req
Auto-Req: Enabled
User-Detect : Enabled
Packet-Num : 0
Req-Interval: 30 Second

```

└───

show dot1x auto-req	

└───

	-	-

30.1.3 dot1x auto-req req-interval

no

dot1x auto-req req-interval *interval*

no dot1x auto-req req-interval

	<i>interval</i>	s

30

show dot1x auto-req

802.1x

60s

30.1.4 dot1x auto-req user-detect

no

dot1x auto-req user-detect

no dot1x auto-req user-detect

-	-

└───

└───

└───

show dot1x auto-req

└───

```
Ruijie# configure terminal
Ruijie(config)# dot1x auto-req user-detect
Ruijie(config)# end
Ruijie# show dot1x auto-req
Auto-Req: Enabled
User-Detect : Enabled
Packet-Num : 0
Req-Interval: 60 Second
```

└───

show dot1x auto-req	

└───

└───

-	-

30.2 dot1x

30.2.1 dot1x timeout quiet-period

no

dot1x timeout quiet-period *seconds*

no dot1x timeout quiet-period

<i>seconds</i>	0 65535 s

10

show dot1x

```

1000s
Ruijie# configure terminal
Ruijie(config)# dot1x timeout quiet-period 1000
Ruijie(config)# end
Ruijie# show dot1x
802.1X Status:      Enabled
Authentication Mode: EAP-MD5
Authed User Number: 0
Re-authen Enabled:  Disabled
Re-authen Period:   3600 sec
Quiet Timer Period: 1000 sec
Tx Timer Period:    3 sec
Supplicant Timeout: 3 sec
Server Timeout:     5 sec
Re-authen Max:      3 times
Maximum Request:    3 times
Filter Non-RG Supp: Disabled

```

Client Oline Probe: Disabled
Eapol Tag Enable: Disabled
Authorization Mode: Group Server

show dot1x	802.1x

	-

period

seconds

Re-authen Period: 1000 sec
Quiet Timer Period: 1000 sec
Tx Timer Period: 3 sec
Supplicant Timeout: 3 sec
Server Timeout: 5 sec
Re-authen Max: 3 times
Maximum 2Request: 3 times
Filter Non-RG Supp: Disabled
Client Oline Probe: Disabled
Eapol Tag Enable: Disabled
Authorization Mode: Group Server



-	-
---	---

30.2.5 dot1x timeout tx-period

no

dot1x timeout tx-period *seconds*

no dot1x timeout tx-period

<i>seconds</i>	0 65535

3

show dot1x 802.1x

10s

```
Ruijie# configure terminal
Ruijie(config)# dot1x timeout tx-period 10
Ruijie(config)# end
Ruijie# show dot1x
802.1X Status:      Enabled
Authentication Mode: EAP-MD5
Authed User Number: 0
Re-authen Enabled:  Disabled
Re-authen Period:   1000 sec
Quiet Timer Period: 1000 sec
Tx Timer Period:    10 sec
Supplicant Timeout: 10 sec
Server Timeout:     10 sec
Re-authen Max:      3 times
Maximum Request:    3 times
Filter Non-RG Supp: Disabled
Client Oline Probe: Disabled
Eapol Tag Enable:   Disabled
```

Authorization Mode: Group Server



show dot1x

802.1x

```

Re-authen Period:    1000 sec
Quiet Timer Period:  1000 sec
Tx Timer Period:     10 sec
Supplicant Timeout:  10 sec
Server Timeout:      10 sec
Re-authen Max:       3 times
Maximum Request:     3 times
Filter Non-RG Supp:  Disabled
Client Oline Probe:  Disabled
Eapol Tag Enable:    Disabled
Authorization Mode:   Group Server

```

show dot1x	802.1x

-	-

30.3.2 dot1x reauth-max

no

dot1x reauth-max *count*

no dot1x reauth-max

<i>count</i>	

3

show dot1x

802.1x

```

Ruijie# configure terminal
Ruijie(config)# dot1x reauth-max 5
Ruijie(config)# end
Ruijie# show dot1x
802.1X Status:          Enabled
Authentication Mode:   EAP-MD5
Authenticated User Number: 0
Re-authen Enabled:    Enabled
Re-authen Period:     1000 sec
Quiet Timer Period:   1000 sec
Tx Timer Period:      10 sec
Supplicant Timeout:   10 sec
Server Timeout:       10 sec
Re-authen Max:        5 times
Maximum Request:      3 times
Filter Non-RG Supp:   Disabled
Client Oline Probe:   Disabled
Eapol Tag Enable:     Disabled
Authorization Mode:   Group Server

```

show dot1x	802.1x

-	-

30.4 dot1x

30.4.1 dot1x probe-timer

dot1x probe-timer{interval | alive}*interval*

no dot1x probe-timer

no	
<i>interval</i>	hello
alive	
interval	

```
Hello          20
                250
```

```
show dot1x      802.1x
```

```
hello          30 ,          120
Ruijie# configure terminal
Ruijie(config)# dot1x probe-timer interval 30
Ruijie(config)# dot1x probe-timer alive 120
Ruijie(config)# end
Ruijie# show dot1x probe-timer
Hello Interval: 30 Seconds
Hello Alive: 120 Seconds
```

Show dot1x probe-timer	
-------------------------------	--

	-	-
--	---	---

--	--	--

--	--	--

--	--	--

```
Ruijie# configure terminal
Ruijie(config)# dot1x client-probe enable
Ruijie(config)# end
Ruijie# show dot1x
802.1X Status:      Enabled
Authentication Mode: EAP-MD5
Authed User Number: 0
Re-authen Enabled:  Enabled
Re-authen Period:  1000 sec
Quiet Timer Period: 1000 sec
Tx Timer Period:   10 sec
Supplicant Timeout: 10 sec
Server Timeout:   10 sec
```

30.5 dot1x

30.5.1 dot1x authentication

AAA

AAA

no**dot1x authentication {default | list-name}****no dot1x authentication {default | list-name}**

default	
<i>list-name</i>	

AAA

AAA

AAA

dot1x

group radius

```

Ruijie# configure terminal
Ruijie(config)# aaa new-model
Ruijie(config)# aaa authentication dot1x default group radius
Ruijie(config)# interface fastEthernet0/1
Ruijie(config-if)# dot1x authentication default
Ruijie(config-if)# end

```

aaa new-model	AAA
aaa authentication dot1x	

-	-

30.5.2 dot1x auth-address-table

802.1X

no

dot1x auth-address-table address *mac-addr* **interface** *interface*

no dot1x auth-address-table address *mac-addr* **interface** *interface*

<i>mac-addr</i>	
<i>Interface</i>	

S*ü

table

802.1X

show dot1x auth-address

dot1x auth-mode {eap-md5 | chap | pap}

no dot1x auth-mode

eap-md5	802.1x	EAP-MD5
chap	802.1x	CHAP
pap	802.1x	PAP

EAP-MD5

show dot1x 802.1x

802.1x

```
Ruijie# configure terminal
Ruijie(config)# dot1x auth-mode chap
Ruijie(config)# end
Ruijie#
```

show dot1x	802.1x

```
show dot1x 802.1x
```

```
802.1x
```

```
Ruijie# configure terminal
Ruijie(config)# dot1x default
Ruijie(config)# end
Ruijie# end
```

show dot1x	802.1x

-	-

30.5.5 dot1x dynamic-vlan enable

vlan

no

dot1x dynamic-vlan enable

no dot1x dynamic-vlan enable

-	-

```
show dot1x dynamic-vlan 802.1x
```

```
802.1x vlan
```

```
Ruijie# configure terminal
```

```
Ruijie(config)# dot1x dynamic-vlan enable
Ruijie(config)# end
Ruijie#
```

show dot1x	802.1x

-	-

30.5.6 dot1x guest-vlan

```

      guest vlan          no
dot1x dynamic-vlan <1 - 4094>
no dot1x guest-vlan

```

vid	<1 - 4094>

```

>          guest vlan          dot1x dynamic-vlan enable
      guest vlan
>          guest vlan
      vlan
>          show running-config      802.1x

```

```

      802.1x guest vlan
Ruijie# configure terminal
Ruijie(config)# dot1x guest-vlan 10
Ruijie(config)# end
Ruijie#
```

	show running-config	802.1x

	-	-

30.5.7 dot1x eapol-tag

EAPOL TAG

dot1x eapol-tag

no dot1x eapol-tag

	-	-

|

|

|

show dot1x 802.1x

|

802.1X tag

```
Ruijie# configure terminal
Ruijie(config)# dot1x eapol-tag
Ruijie(config)# end
Ruijie#
```

|

show dot1x		802.1x

|

|

	-	-

30.5.8 dot1x max-req

DOT1X

DOT1X

DOT1X

no

dot1x max-req *count*

no dot1x max-req



show dot1x private-supPLICANT-only 802.1x

```
Ruijie# configure t
Ruijie(config)# dot1x private-supPLICANT-only
Ruijie(config)# end
Ruijie#
```

show dot1x private-supPLICANT-only	

-	-

30.5.10 dot1x port-control auto

no

```
dot1x port-control auto
no dot1x port-control
```



```
Ruijie#
```

show dot1x	802.1x

-	-

30.5.11 dot1x port-control-mode

802.1x

MAC

dot1x port-control-mode {mac-based | {port-based [single-host]} }

no dot1x port-control-mode

mac-based	mac 802.1X
port-based	802.1X
single-host	802.1x

```
mac-based
```

```

show dot1x port-control 802.1x
single-host 802.1x show dot1x port-control
port-based show running-config dot1x port-control-mode
port-based single-host
single-host default-user-limit single-host
single-host default-user-limit

```

```
single-host
```

```

1          802.1x
Ruijie(config)# interface g 0/1
Ruijie(config-if)# dot1x port-control auto
Ruijie(config-if)# dot1x port-control-mode port-based
Ruijie(config-if)# end
Ruijie#

2          802.1x
Ruijie(config)# interface g 0/1
Ruijie(config-if)# dot1x port-control auto
Ruijie(config-if)# dot1x port-control-mode port-based single-host
Ruijie(config-if)# end
Ruijie#

```

show dot1x port-control	802.1x
Show running-config	

-	-

30.5.12 dot1x stationarity enable

802.1x

802.1X

dot1x stationarity enable**no dot1x stationarity enable**

-	-

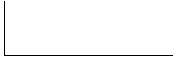

1 ruijie.net/web

Ruijie(config)# **dot1x redirect url** http://ruijie.net/web

dot1x redirect url	
dot1x redirect time-out	
dot1x redirect num for special source-ip	
show dot1x	dot1x

└───┘

-	-

30.5.15 dot1x redirect time-out

(), 3 1-10 no

dot1x redirect time-out port *time-out-interval*

no dot1x redirect time-out port

<i>time-out-interval</i>	

└───┘

3

└───┘

└───┘

└───┘

1 5
Ruijie(config)# **dot1x redirect time-out 5**

dot1x redirect url	web ip ip

dot1x redirect for special tcp-destination port	
dot1x redirect num for special source-ip	
show dot1x	dot1x

└──

-	-

30.5.16 dot1x redirect num for special source-ip

1 1-10 no

dot1x redirect num for special source-ip *num*

no dot1x redirect num for special source-ip

<i>num</i>	

└── 1

└──

└──

1 3

```
Ruijie(config)# dot1x redirect num for special source-ip 3
```

dot1x redirect url	

dot1x redirect for special tcp-destination port

	show dot1x	dot1x
	-	-

30.6 dot1x

30.6.1 show dot1x

802.1x

show dot1x

	-	-

```

Ruijie# show dot1x
802.1X Status:      Enabled
Authentication Mode: EAP-MD5
Authed User Number: 0
Re-authen Enabled: Disabled
Re-authen Period:  3600 sec
Quiet Timer Period: 10 sec
Tx Timer Period:   3 sec
Supplicant Timeout: 3 sec
Server Timeout:   5 sec
Re-authen Max:    3 times
Maximum Request:  3 times

```

```

Filter Non-RG Supp: Disabled
Client Oline Probe: Disabled
Eapol Tag Enable: Disabled
Authorization Mode: Group Server
Ruijie#
    
```

dot1x auth-mode	802.1x
dot1x max-req	
dot1x port-control auto	
dot1x reauth-max	
dot1x re-authentication	
dot1x timeout quiet-period	
dot1x timeout re-authperiod	
dot1x timeout server-timeout	
dot1x timeout supp-timeout	
dot1x timeout tx-period	

-	-
---	---

802.1X

show dot1x auth-address-table*[addressmac-addr][interface interface]*

<i>mac-addr</i>	<i>interface</i>

└───

└───

└───

```
Ruijie# show dot1x auth-address-table
interface:g3/1
-----
mac addr: 00D0.F800.0001
Ruijie#
```

dot1x auth-mode	802.1x
dot1x max-req	
dot1x port-control auto	
dot1x reauth-max	
dot1x re-authentication	
dot1x timeout quiet-period	
dot1x timeout re-authperiod	
dot1x timeout server-timeout	
dot1x timeout supp-timeout	
dot1x timeout tx-period	

└───

└───

-	-

30.6.3 show dot1x auto-req

802.1x

show dot1x auto-req

-	-

└──

└──

└──

```
Ruijie# show dot1x auto-req
Auto-Req: Disabled
User-Detect : Enabled
Packet-Num  : 0
Req-Interval: 30 Seconds
```

dot1x auth-mode	802.1x
dot1x max-req	
dot1x port-control auto	
dot1x reauth-max	
dot1x re-authentication	
dot1x timeout quiet-period	
dot1x timeout re-authperiod	
dot1x timeout server-timeout	
dot1x timeout supp-timeout	
dot1x timeout tx-period	

	-	-

30.6.4 show dot1x private-supPLICANT-only

show dot1x private-supPLICANT-only

	-	-

|

|

|

```
Ruijie# show dot1x private-supPLICANT-only
private-supPLICANT-only:: disabled
Ruijie#
```

	dot1x timeout supp-timeout	
	dot1x timeout tx-period	

30.6.5 show dot1x max-req

show dot1x max-req

-	-

└───┘

└───┘

└───┘

```
Ruijie# show dot1x max-req
max-req: 2 times
Ruijie#
```

dot1x auth-mode	802.1x
dot1x max-req	
dot1x port-control auto	
dot1x reauth-max	
dot1x re-authentication	
dot1x timeout quiet-period	
dot1x timeout re-authperiod	
dot1x timeout server-timeout	
dot1x timeout supp-timeout	
dot1x timeout tx-period	

└───┘

-	-

30.6.6 show dot1x port-control

show dot1x port-control [*interface interface*]

<i>interface</i>	

└───

└───

└───

```
Ruijie# show dot1x port-control
interface dyn-user static-user max-user qos
ctrl-mode status
-----
Gi0/1      0          1          6000      dscp: 0 mac-base Authed
Ruijie#
```

dot1x auth-mode	802.1x
dot1x max-req	
dot1x port-control auto	
dot1x reauth-max	
dot1x re-authentication	
dot1x timeout quiet-period	
dot1x timeout re-authperiod	

	dot1x timeout server-timeout	
	dot1x timeout supp-timeout	
	dot1x timeout tx-period	

dot1x auth-mode	802.1x
dot1x max-req	
dot1x port-control auto	
dot1x reauth-max	
dot1x re-authentication	
dot1x timeout quiet-period	
dot1x timeout re-authperiod	
dot1x timeout server-timeout	
dot1x timeout supp-timeout	
dot1x timeout tx-period	

└───

-	-

30.6.9 show dot1x reauth-max

show dot1x reauth-max

-	-

└───

└───

└───

```
Ruijie# show dot1x reauth-max
reauth-max: 2 times
Ruijie#
```

dot1x auth-mode	802.1x
dot1x max-req	
dot1x port-control auto	
dot1x reauth-max	
dot1x re-authentication	
dot1x timeout quiet-period	
dot1x timeout re-authperiod	
dot1x timeout server-timeout	
dot1x timeout supp-timeout	
dot1x timeout tx-period	

-	-

30.6.10 show dot1x summary

802.1X

show dot1x summary

-	-

```

Ruijie# show dot1x summary
ID      MAC          Interface VLAN Auth-State
Backend-State Port-Status Type
-----
1 00d0f8000000 Gi0/1      1 Authenticated Idle
Authed   Static
Ruijie#
    
```

dot1x auth-mode	802.1x
dot1x max-req	
dot1x port-control auto	
dot1x reauth-max	
dot1x re-authentication	
dot1x timeout quiet-period	
dot1x timeout re-authperiod	
dot1x timeout server-timeout	
dot1x timeout supp-timeout	
dot1x timeout tx-period	

-	-
---	---

30.6.11 show dot1x user id

802.1X

show dot1x user id <id>

<i>id</i>	show summary	id
-----------	--------------	----

```
Ruijie# show dot1x user id 1
```

```
User name: caikov
```

```
id: 1
```

```
Type: static
```

```
Mac address is 0013.2049.8272
```

```
Vlan id is 217
```

```
Access from port Gi0/13
```

```
User ip address is 192.168.217.64
```

```
Max user number on this port is 6000
```

```
COS on this port is 5
```

```
Up-bandwidth is 1024 kbps
```

```
Down-bandwidth is 1024 kbps
```

```
Authorization vlan is dep7
```

```
Authorization session time is 1000000 seconds
```

```
Authorization ip address is 192.168.217.64
```

```
Start accounting
```

```
Permit proxy user
```

```
Permit dial user
```

```
IP privilege is 2
```

dot1x auth-mode	802.1x
------------------------	--------

dot1x max-req	
dot1x port-control auto	

```
Ruijie# show dot1x timeout quiet-period
quiet-period: 60 sec
Ruijie#
```

dot1x auth-mode	802.1x
dot1x max-req	
dot1x port-control auto	
dot1x reauth-max	
dot1x re-authentication	

```
dot1x timeo/Tpf-0.0024 Tw 1.198 <4-0.0024 Tw 1.] 0.47A48 20.1 33.36 394.9840.1 F909E20804
```

31 AAA

31.1

31.1.1 aaa authentication dot1x

AAA

AAA Enable

RADIUS

RADIUS

```
Ruijie(config)# aaa authentication enable default group radius local
```

aaa new-model	AAA
enable	
username	

-	-

31.1.3 aaa authentication login

AAA

Login

aaa authentication login

```
Login no
```

```
aaa authentication login {default | list-name} method1 [method2...]
```

```
no aaa authentication login {default | list-name}
```

default	Login
<i>list-name</i>	Login
<i>method</i>	" local none group" 4
local	
none	
group	TACACS+ RADIUS

┌

```

AAA
aaa authentication login
Login
AAA Login
Login

```

┌

```

list-1 AAA Login
RADIUS RADIUS
Ruijie(config)# aaa authentication login list-1 group radius local

```

┌

aaa new-model	AAA
username	
login authentication	Login

┌

┌

-	-

31.1.4 aaa authentication ppp

```

AAA PPP
aaa authentication ppp PPP

```

local	
none	
group	TACACS+ RADIUS

┌
└

AAA PPP AAA PPP
aaa authentication ppp PPP

rds_ppp AAA PPP RADIUS RADIUS
 Ruijie(config)# **aaa authentication ppp rds_ppp group radius local**

aaa new-model	AAA
ppp authentication	PPP
username	

┌
└

-	-
---	---

31.1.5 login authentication

authentication Login no **login**

login authentication {default | list-name}

no login authentication

--	--

default	Login
<i>list-name</i>	Login

Login
Login
Login

```
list-1 AAA Login
VTY 0 - 4
Ruijie(config)# aaa authentication login list-1 local
Ruijie(config)# line vty 0 4
Ruijie(config-line)# login authentication list-1
```



no aaa authorization commands *level* {**default** | *list-name*}

<i>level</i>	0~15
default	Q

	-	-

└──

└──

└── RGOS

└── Ruijie(config)# **aaa authorization console**

aaa new-model	AAA
aaa authorization commands	AAA
authorization commands	

└──

-	-

31.2.4 aaa authorization exec

AAA NAS CLI Exec
aaa authorization exec no AAA Exec

aaa authorization exec {default | *list-name*} *method1* [*method2...*]

no aaa authorization exec {default | *list-name*}

default	Exec
<i>list-name</i>	Exec

AAA

default	Network
<i>method</i>	"

authorization

commands no

authorization commands *level* {**default** | *list-name*}

no authorization commands *level*

<i>level</i>	0~15
default	
<i>list-name</i>	

AAA

cmd 15 TACACS+
none VTU 0-4

```
Ruijie(config)# aaa authorization commands 15 cmd group tacacs+ none
Ruijie(config)# line vty 0 4
Ruijie(config-line)# authorization commands 15 cmd
```

aaa new-model	AAA
aaa authorization commands	AAA

Exec **authorization exec**
 no Exec

authorization exec {default | list-name}

no authorization exec

default	Exec
<i>list-name</i>	Exec

AAA Exec

Exec
 Exec Exec Exec

exec-1 Exec RADIUS
 none VTY 0 – 4
 Ruijie(config)# **aaa authorization exec exec-1 group radius none**
 Ruijie(config)# **line vty 0 4**
 Ruijie(config-line)# **authorization exec exec-1**

aaa new-model	AAA
aaa authorization commands	AAA Exec

-	-

31.3

NAS

aaa accounting commands no

aaa accounting commands *level* {**default** | *list-name*} **start-stop** *method1* [*method2...*]

no aaa accounting commands *level* {**default** | *list-name*}

<i>level</i>	0~15
default	
<i>list-name</i>	
<i>method</i>	" none group" 4

	-	-

31.3.2 aaa accounting exec

NAS aaa

accounting exec no Exec

aaa accounting exec {default | *list-name*} start-stop *method1* [*method2...*]

no aaa accounting exec {default | *list-name*}

default	Exec
<i>list-name</i>	Exec
<i>method</i>	" none group" 4
none	

aaa new-model	AAA
aaa authentication	AAA
accounting commands	Exec
-	-

31.3.3 aaa accounting network

aaa accounting network no

aaa accounting network {default | *list-name*} **start-stop** *method1* [*method2...*]

no aaa accounting network {default | *list-name*}

default	Network
<i>list-name</i>	
start-stop	
<i>method</i>	4
none	
group	

```
Ruijie(config)# aaa accounting network default start-stop group
radius
```

aaa new-model	AAA
aaa authorization network	AAA
aaa authentication	AAA
username	

-	-

31.3.4 aaa accounting update

aaa accounting update

no

aaa accounting update

no aaa accounting update

-	-

AAA

AAA

```
Ruijie(config)# aaa new-model
```

```
Ruijie(config)#
```

--	--

aaa new-model	AAA
aaa accounting network	

└───┘

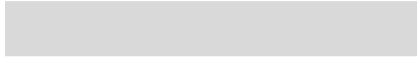

	-	-

31.3.6 accounting commands

accounting commands

no

accounting commands *level* {**default** | *list-name*}

no accounting commands *level*

<i>level</i>	0~15
default	

-	-

31.3.7 accounting exec

Exec

no

Exec

accounting exec**accounting exec {default | *list-name*}****no accounting exec**

default	Exec
<i>list-name</i>	Exec

┌

└

┌

└

┌

└

Exec

Exec

Exec

Exec

┌

└

exec-1 Exec

none

RADIUS

VTY 0 – 4

```
Ruijie(config)# aaa accounting exec exec-1 group radius none
```

```
Ruijie(config)# line vty 0 4
```

```
Ruijie(config-line)# accounting exec exec-1
```

aaa new-model	AAA
aaa accounting commands	AAA Exec

┌

└

┌

└

--	--

	-	-
--	---	---

31.4 AAA

31.4.1 aaa domain

no

aaa domain {**default** | *domain-name*}

no aaa domain {**default** | *domain-name*}

	default	
	<i>domain-name</i>	

┌

┌

┌

AAA default
 domain-name

32

┌

```
Ruijie(config)# aaa domain ruijie.com
Ruijie(config-aaa-domain)#
```

	aaa new-model	AAA
	aaa domain enable	AAA
	show aaa domain	

┌

┌

--	--	--

31.4.2 aaa domain enable

AAA
AAA no

aaa domain enable

no aaa domain enable

	-	-

┌
└

AAA

┌
└

AAA

┌
└

AAA

Ruijie(config)# **aaa domain enable**

aaa new-model		AAA
show aaa domain		

┌
└

	-	-

31.4.3 access-limit

no access-limit

<i>num</i>	IEEE802.1x

┌

┌

┌

┌
ruijie.com
Ruijie(config)# **aaa domain** ruijie.com
Ruijie(config-aaa-domain)# **access-limit** 20

A	A	A
AAA		

┌

--	--



N e n t o w

accounting { }

default S*A-D&S*6,Ö!5B*Ö<	



default

Network

Network

Ruijie(config)# **aaa domain ruijie.com**

Ruijie(config-aaa-domain)# **accounting network default**

aaa new-model	AAA
aaa domain enable	AAA
show aaa domain	

-	-

31.4.5 authentication dot1x

IEEE802.1x

no

authentication dot1x {default | list-name}

no authentication dot1x

default	
<i>list-name</i>	

default

```
IEEE802.1x
```

```
IEEE802.1x
```

```
Ruijie(config)# aaa domain ruijie.com
```

```
Ruijie(config-aaa-domain)# authentication dot1x default
```

aaa new-model	AAA
aaa domain enable	AAA
show aaa domain	

-	-

31.4.6 authorization network

```
Network no
```

```
authorization network {default | list-name}
```

```
no authorization network
```

default	
<i>list-name</i>	

```
default
```

```
Ruijie(config)# aaa domain ruijie.com
```

```
Ruijie(config-aaa-domain)# authorization network default
```

aaa new-model	AAA
aaa domain enable	AAA
show aaa domain	

-	-

31.4.7 state

no

state {block | active}

no state

block	
active	

```
Ruijie(config)# aaa domain ruijie.com
```

```
Ruijie(config-aaa-domain)# state block
```

--	--

aaa new-model	AAA
aaa domain enable	AAA
show aaa domain	

AAA

aaa new-model

AAA

-	-

31.5 AAA

31.5.1 aaa group server

AAA no

aaa group server {radius | tacacs+} name

no aaa group server {radius | tacacs+} name

<i>name</i>	" tacacs+" " radius" RADIUS TACACS+

└───

└───

└───

AAA RADIUS TACACS+

└───

```
Ruijie(config)# aaa group server radius ss
```

```
Ruijie(config-gs-radius)# end
```

```
Ruijie# show aaa group
```

```
Group Name:  ss
```

```
Group Type:  radius
```

```
Referred:   1
```

```
Server List:
```

show aaa group	aaa

└───

	-	-

31.5.2 ip vrf forwarding

AAA vrf no

ip vrf forwarding *vrf_name*

no ip vrf forwarding

	<i>vrf_name</i>	vrf

└──

└──

└──

vrf

└──

```
Ruijie(config)# aaa group server radius ss
Ruijie(config-gs-radius)# server 192.168.4.12
Ruijie(config-gs-radius)# server 192.168.4.13
Ruijie(config-gs-radius)# ip vrf forwarding vrf_name
Ruijie(config-gs-radius)# end
```

	aaa group server	aaa
	show aaa group	aaa

└──

AAA no

server *ip-addr* [**authen-port** *port1*] [**acct-port** *port2*]

no server

AAA

	-	-
--	---	---

31.5.4 show aaa group

AAA

show aaa group



31.6.1 aaa local authentication attempts

login

aaa local authentication attempts *max-attempts*

	<i>max-attempts</i>	1~2147483647

|

3

|

|

Login

D

|

| login

|

Ruijie# **configure terminal**
 Ruijie(config)# **aaa local authentication lockout-time 5**

|

Show running-config	
Show aaa lockout	login

|

|

-	-

31.6.3 aaa new-model

RGOS AAA **aaa new-model** AAA
 no AAA

aaa new-model

no aaa new-model

|

-	-

| AAA

|

|

AAA AAA **aaa new-model**
 AAA AAA AAA

|

AAA
 Ruijie(config)# **aaa new-model**

	aaa authentication	
	aaa authorization	
	aaa accounting	

└───┘

	-	-

31.6.4 clear aaa local user lockout

clear aaa local user lockout {all | user-name <word>}

	<word>	ID

└───┘

└───┘

31.6.5 debug aaa

AAA

no

debug aaa event

no debug aaa event

	-	-

┌

┌ EXEC

┌

┌

	-	-

┌

	-	-

31.6.6 show aaa method-list

AAA

show aaa method-list

	-	-

┌

~

AAA

AAA

Ruijie# **show aaa method-list**

Authentication method-list

aaa authentication login default group radius

aaa authentication ppp default group radius

aaa authentication dot1x default group radius

aaa authentication dot1x san-f local group angel group rain none

aaa authentication enable default group radius

Accounting method-list

aaa accounting network default start-stop group radius

Authorization method-list

aaa authorizing network default group radius

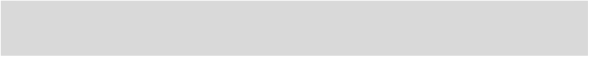

|

|

Ruijie# **show aaa user lockout all**

|

show running-config	
show aaa lockout	login

|

|

-	-

32.1.2 radius attribute

radius ttribute{<id> | **down-rate-limit** | **dscp** | **mac-limit** | **up-rate-limit**} **vendor-type**
<type>

no radius attribute {<id>|**down-rate-limit** | **dscp** | **mac-limit** | **up-rate-limit**} **vendor-type**

<i>id</i>	id <1-255>
<i>type</i>	type

id		type
1	max down-rate	1
2	qos	2
3	user ip	3
4	vlan id	4
5	version to client	5
6	net ip	6
7	user name	7
8	password	8
9	file-diractory	9
10	file-count	10
11	file-name-0	11
12	file-name-1	12
13	file-name-2	13
14	file-name-3	14
15	file-name-4	15
16	max up-rate	16
17	version to server	17
18	flux-max-high32	18
19	flux-max-low32	19
20	proxy-avoid	20
21	dailup-avoid	21
22	ip privilege	22

23	login privile	42
----	---------------	----

RADIUS

radius-server key

RADIUS

radius-server retransmit

RADIUS

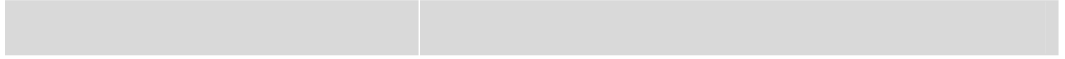

RADIUS

radius-server timeout no

radius-server timeout *seconds*

no radius-server timeout

<i>seconds</i>		1-1000

5

10
Ruijie(config)# **radius-server timeout 10**

radius-server host		RADIUS
radius-server retransmit		RADIUS
radius-server key		RADIUS

-		-

32.1.8 radius set qos cos

radius qos cos

radius set qos cos

no radius set qos cos

-		-

RADIUS

	radius attribute		
	radius set	qos	cos
	-		-

32.2 RADIUS

32.2.1 debug radius

RADIUS

no

RADIUS

debug radius [event | detail]

no debug radius [event | detail]

	-	-



EXEC



	-	-



RADIUS

show radius parameter

-	-

|

|

|

radius

|

```
Ruijie# show radius parameter
Server Timeout: 5 Seconds
Server Deadtime: 5 Minutes
Server Retries: 3
Server Key: *****
```

|

radius-server host	RADIUS
radius-server retransmit	RADIUS
radius-server key	RADIUS
radius-server timeout	RADIUS

|

|

-	-

┌

┌

┌

radius

┌

```
Ruijie# show radius server
server ip : 192.168.4.12
acct port: 23
authen port: 77
server state: ready
server ip : 192.168.4.13
acct port: 45
authen port: 74
server state: ready
```

┌

radius-server host	RADIUS
radius-server retransmit	RADIUS
radius-server key	RADIUS
radius-server timeout	RADIUS

┌

┌

-	-

32.2.4 show radius vendor-specific

RADIUS

show radius vendor-specific

┌

-	-

┌

└───

└───

radius

```
Ruijie# show radius vendor-specific
id   vendor-specific      type-value
-----
1    max down-rate         76
2    qos                   77
3    user ip              3
4    vlan id              4
5    version to client    5
6    net ip               6
7    user name            7
8    password             8
```

RADIUS

L

L

-	-

33 TACACS+

33.1 TACACS+

33.1.1 aaa group server tacacs+

TACACS+

TACACS+

```
aaa group server tacacs+ group-name
```

```
no aaa group server tacacs+ group-name
```

	<i>group-name</i>	TACACS+

```
TACACS+
```

```
TACACS+
```

```

tac1 TACACS+ 1.1.1.1
TACACS+
Ruijie(config)# aaa group server tacacs+ tac1
Ruijie(config-gs-tacacs)# server 1.1.1.1
```

server	TACACS+	server
ip vrf forwarding	TACACS+	VRF

-	-	-

33.1.2 ip tacacs source-interface

TACACS+

ip tacacs source-interface *interface*

no ip tacacs source-interface



<i>vrf-name</i>	vrf
-----------------	-----

TACACS+

TACACS+ vrf

```

TACACS+ VRF vpn1
Ruijie(config)# aaa group server tacacs+ tac1
Ruijie(config-gs-radius)# server 1.1.1.1
Ruijie(config-gs-radius)# ip vrf forwarding vpn1
    
```

aaa group server tacacs+	TACACS+
server	TACACS+ server

--	--

```
TACACS+          aaa group server tacacs+  TACACS+
host           tacacs-server
```

```
TACACS+
```

```
          tac1  TACACS+          1.1.1.1
TACACS+
```

```
Ruijie(config)# aaa group server tacacs+ tac1
```

```
Ruijie(config-gs-tacacs+)# server 1.1.1.1
```



|
|

|
|

TACACS+ AAA TACACS+
tacacs-server TACACS+

|
|

TACACS+
Ruijie(config)# **tacacs-server host** 192.168.12.1
Ruijie(config)# **tacacs-server host** 2001::1

|
|

aaa authentication	AAA
tacacs-server key	TACACS+
tacacs-server timeout	TACACS+

|
|

|
|

```

key                               host      key

```

```

TACACS+
Ruijie(config)#tacacs-server key aaa

```

tacacs-server host	TACACS+
tacacs-server timeout	TACACS+

-	-

33.1.7 tacacs-server timeout

TACACS+

tacacs-server timeout *seconds*

no tacacs-server timeout

--	--

seconds

tacacs-server host	TACACS+
tacacs-server key	TACACS+

	-	

33.2 TACACS+

33.2.1 debug tacacs+

TACACS+ no TACACS+

debug tacacs+

no debug tacacs+

--	--

33.2.2 show tacacs

TACACS+

show tacacs

	-	-

|

|

|

TACACS+

```
Ruijie# show tacacs
Tacacs+ Server : 172.19.192.80/49
Socket Opens: 0
Socket Closes: 0
Total Packets Sent: 0
Total Packets Recv: 0
Reference Count: 0
```

|

tacacs-server host	TACACS+

|

|

-	-

34 SSH

34.1 SSH

34.1.1 crypto key generate

crypto key generate {rsa | dsa}

rsa	RSA
dsa	DSA

SSH Server

SSH Server

SSH

enable service ssh-server

SSH Server

SSH 1

RSA

SSH

2 RSA DSA

RSA

SSH1

SSH2

DSA

SSH2

no crypto key generate



crypto key zeroize

Ruijie# **configure terminal**

Ruijie(config)# **crypto key generate rsa**

show ip ssh	SSH Server
crypto key zeroize {rsa dsa}	DSA RSA SSH Server

RGOS10.1

	-	-
--	---	---

34.1.2 crypto key zeroize

SSH

crypto key zeroize {rsa / dsa}

rsa		RSA
dsa		DSA

--

--

	SSH Server	SSH Server	DISABLE
		no enable service ssh-server	

```
Ruijie# configure terminal
Ruijie(config)# crypto key zeroize rsa
```

show ip ssh		SSH Server
crypto key generate {rsa dsa}		DSA RSA

RGOS10.1

-		-

34.1.3 ip ssh authentication-retries

SSH Server

no

ip ssh authentication-retries *retry times*

no ip ssh authentication-retries

<i>retry times</i>	

3 no ip ssh

authentication-retries

SSH Server SSH Server

show ip ssh SSH Server

2

Ruijie# **configure terminal**

Ruijie(config)# **ip ssh ssh authentication-retries 2**

show ip ssh	SSH Server

RGOS10.1

-	-

34.1.4 ip ssh time-out

SSH Server no

ip ssh time-out *time*

no ip ssh time-out

<i>time</i>	

120s no ip ssh time-out



SSH Server
120s

2

```
Ruijie# configure terminal  
Ruijie(config)# ip ssh version 2
```

Q,

show ip ssh

SSH Server

RGOS10.1

	Clear line vty <i>line_number</i>	VTY
	RGOS10.1	
	-	-

34.2.2 show crypto key mypubkey

SSH Server

show crypto key mypubkey {rsa/dsa}

	rsa	RSA
	dsa	DSA

SSH Server

Ruijie# **show crypto key mypubkey rsa**

	crypto key generate {rsa dsa}	DSA RSA
	RGOS10.1	
	-	-

34.2.3 show ip ssh

SSH Server

show ip ssh

-	-

└───

└───

SSH Server	SSH Server
SSH	
SSH	

└───

Ruijie# **show ip ssh**

ip ssh version {1 2}	SSH Server
ip ssh time-out time	SSH Server
ip ssh authentication-retries retry times	SSH Server

└───

RGOS10.1

-	-

34.2.4 show ssh

SSH

show ssh

-	-

└───

|

|

SSH

VTY

SSH

|

Ruijie# **show ssh**

|

-	-

|

RGOS10.1

|

--	--

35 CPU

35.1

35.1.1 `cpu-protect type packet-type pps pps_value`

CPU

`cpu-protect type { arp | bpdu | dhcp | ipv6mc | igmp | rip | ospf | vrrp | pim | ttl1 |
unknown-ipmc | dvmrp | ... } pps pps_value`

CPU

CPU

```

S9610 CPU
Ruijie# show cpu-protect mboard
type      Pps      Total    Drop
-----
arp       500      19       0
bpdu     200      24       0
dhcp      0         0       0
gvrp      0         0       0
ipv6-mc   0         0       0
dvmrp     0         0       0
igmp      0         0       0
ospf      0         0       0
pim       0         0       0
rip       0         0       0
vrrp      0         0       0
unknow-ipmc 0         0       0
ttl1      0         0       0
...

```

show cpu-protect slot <i>slot-num</i>	CPU

-	-

35.2.2 show cpu-protect slot

CPP

show cpu-protect slot *slot_num*

--	--

<i>slot_num</i>	1-16
-----------------	------

CPP

2 CPU

Ruijie(config)# **show cpu-protect slot 2**

Type	Pps	Total	Drop
arp	200	200	15
bpdu	200	8	0
dhcp	200	0	0
gvrp	200	0	0
ipv6-mc	200	0	0
dvmrp	200	0	0
igmp	200	0	0
ospf	200	0	0
pim	200	0	0
rip	200	0	0
vrrp	200	0	0
unknow-ipmc	200	0	0
ttl1	20	3	0

show cpu-protect mboard	CPU
--------------------------------	-----

-	-
---	---

35.2.3 show cpu-protect type

show cpu-protect type { arp | bpdu | dhcp | ipv6mc | igmp | rip | ospf | vrrp | pim | ttl1 | unknown-ipmc | dvmrp | ...} *dvmrp*

<i>slot_num</i>	1-16

|

|

|

```

show cpu-protect type bpdu          BPDU
Ruijie(config)# show cpu-protect type arp
Slot      Type      Pps      Total    Drop
-----
MainBoard bpdu      100      30       0
Slot-2    bpdu      100      30       0
    
```

show cpu-protect type <i>packet-type</i>	CPU

-

-	-

	CPP	"..."	CPP

36 DoS

36.1

36.1.1 ip deny invalid-l4port

no

ip deny invalid-l4port

no ip deny invalid-l4port

	-	-

|

|

|

|

1

Ruijie(config)# ip deny invalid-l4port

2

Ruijie(config)# no ip deny invalid-l4port

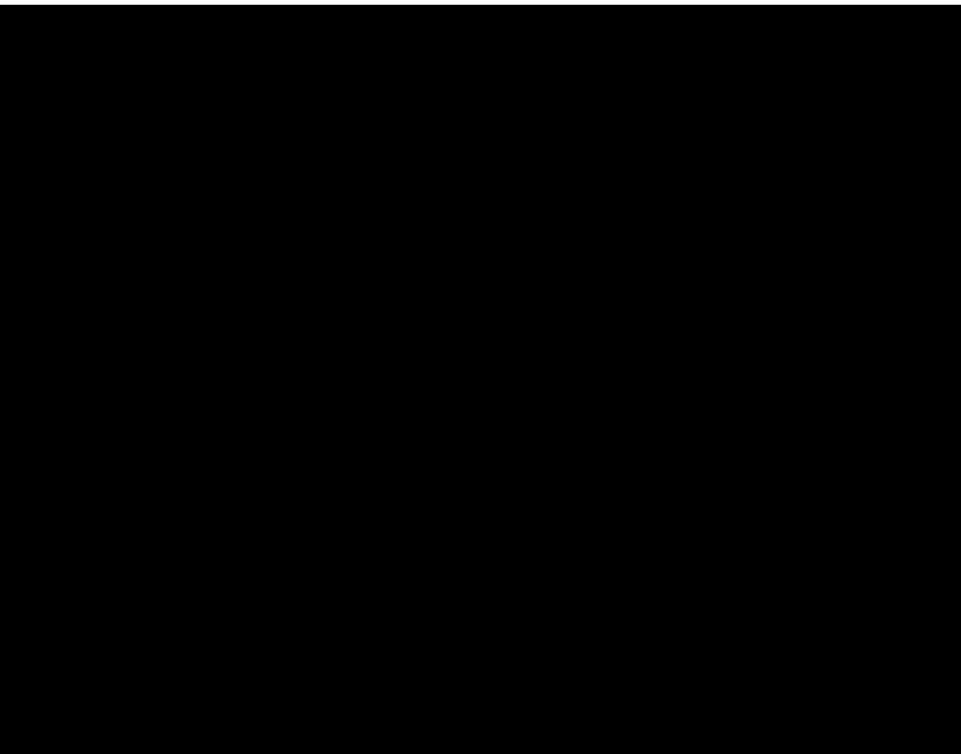

no ip deny invalid-tcp



```

1          Land
Ruijie(config)# ip deny land
2          Land
Ruijie(config)# no ip deny land
    
```

show ip deny land	Land

-	-

36.2

36.2.1 show ip deny invalid-l4port

show ip deny invalid-l4port

-	-

```

┌
└
    
```

```

┌
└
    
```

```

┌
└
    
```

```

Ruijie# show ip deny invalid-l4port
DoS Protection Mode          State
-----
protect against invalid l4port attack Off
    
```

-	-

```

┌
└
    
```

	-	-

36.2.2 show ip deny invalid-tcp

TCP

show ip deny invalid-tcp

	-	-
--	---	---

|

|

|

```
Ruijie# show ip deny land
DoS Protection Mode          State
-----
protect against land attack  On
```

	(no) ip deny land	Land
--	-------------------	------

|

	-	-
--	---	---

37 GSN

37.1

37.1.1 security address-bind enable

security address-bind enable

no security address-bind enable

	-	-

┌

┌

AP AP

┌

GSN

┌

Ruijie(config-if)# security address-bind enable

┌

	security gsn enable	GSN

┌

RGOS10.1

┌

	-	-

37.1.2 security community

smp

security { [v1 | v2] **community** *community* | v3 **user** *username* }

no security { [v1 | v2] **community** *community* | v3 **user** *username* }

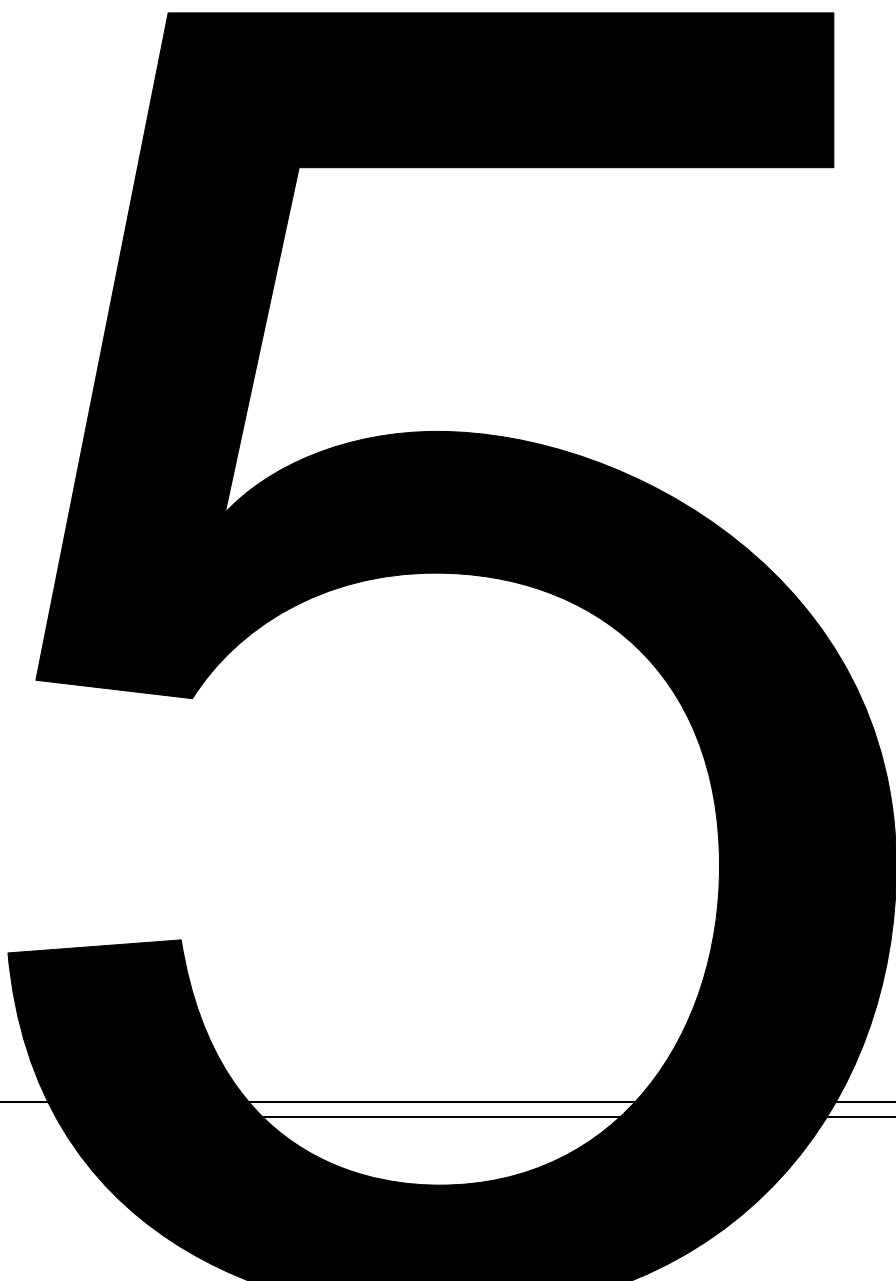
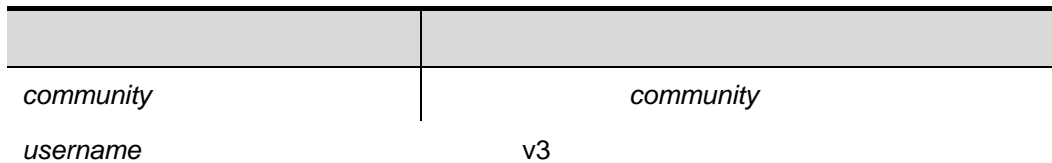

	-	-
	RGOS10.1	
	-	-

37.1.5 smp-server host

smp-server ip

smp-server host *ip-address*

no smp-server host

	<i>ip-address</i>	smp server ip

smp server

show smp-server

Ruijie(config)#**smp-server host** 192.168.4.243

	show smp-server	smp server

RGOS10.1

	-	-

37.2

37.2.1 show security evnet interval

-	-

┌

┌

┌

```
Ruijie# show security event interval
Event sending interval(Seconds):5
```

security event interval <i>interval</i>	

RGOS10.1

-	-

37.2.2 show smp-server

smp server IP

-	-

┌

┌

smp server IP

```
Ruijie# show smp-server
```

SMP-Server IP 192.168.20.30

smp-server host	smp server ip

RGOS10.1

-	-

38 DAI

38.1 VLAN DAI

38.1.1 ip arp inspection vlan

vlan-id VLAN DAI *vlan-id* VLAN DAI
vlan-id VLAN DAI *vlan-id* no VLAN DAI

ip arp inspection vlan *vlan-id*

no ip arp inspection vlan [*vlan-id*]



38.2

38.2.1 ip arp inspection trust

ip arp inspection trust no

ip arp inspection trust

no ip arp inspection trust

-	-

┌

┌

ARP	DAI
NFPP()	NFPP
/	DAI
show ip arp inspection interface	

┌

```

gigabitEthernet 0/19
Ruijie(config)# interface gigabitEthernet 0/19
Ruijie(config-if)# ip arp inspection trust
    
```

show ip arp inspection interface	DAI

┌

-	-

38.3 DHCP Snooping

39

arp

arp

show anti-arp-spoofing

|

|

|

```
Ruijie#show anti-arp-spoofing
      port      ip
      -----
      Fa0/1     192.168.1.1
```

anti-arp-spoofing ip	arp

|

-	-

40 IP Source Guard

40.1 IP Source Guard

40.1.1 ip source binding

IP no

[no] ip source binding *mac-address* **vlan** *vlan-id* *ip-address* **interface** *interface-id*

<i>mac-address</i>	MAC
<i>vlan-id</i>	vlan id
<i>ip-address</i>	IP
<i>interface-id</i>	

|

|

|

IP Source Guard

DHCP

```

1
Ruijie# configure terminal
Ruijie(config)# ip source binding 0000.0000.0001 vlan 1 1.1.1.1
interface FastEthernet 0/1
Ruijie(config)# end
Ruijie# show ip source binding
MacAddress    IpAddress    Lease(sec)   Type         VLAN    Interface
-----
0000.0000.0001 1.1.1.1     infinite     static       1      FastEthernet 0/1
Total number of bindings: 1
    
```

--	--

show ip source binding		IP
	-	-

40.2 IP Source Guard

40.2.1 ip verify source

```

IP Source Guard      no
[no] ip verify source [port-security]

```

port-security	IP Source Guard	IP+MAC

```

IP Source Guard      IP
IP+MAC
IP Source Guard      DHCP Snooping      Trust
DHCP Snooping      IP Source Guard      IP Source Guard

```

```

1      IP Source Guard
Ruijie# configure terminal
Ruijie(config)# interface fastEthernet 0/1
Ruijie(config-if)# ip verify source
Ruijie(config-if)# end

```

-	-

40.3 IP Source Guard

40.3.1 show ip source binding

IP

show ip source binding [*ip-address*] [*mac-address*] [**dhcp-snooping**] [**static**] [*vlan vlan-id*] [**interface** *interface-id*]

<i>ip-address</i>	ip
<i>mac-address</i>	mac
dhcp-snooping	
static	
<i>vlan-id</i>	vlan
<i>interface-id</i>	

└──

└──

└──

└──

```
Ruijie# show ip source binding static
MacAddress  IpAddress  Lease(sec)  Type   VLAN  Interface
-----
0000.0000.0001  1.0.0.1   infinite    static  1    FastEthernet 0/1
Total number of bindings: 1
```

└──

└──

└──

|

|

-	-

|

|

-	-

cpu-protect sub-interface {manage|protocol|route} percent percent_vaule

<i>percent_vaule</i>	1	100

(Manage)	30
(Route)	25
(Protocol)	45

└───┘

└───┘

Ruijie(config)# **cpu-protect sub-interface manage percent 60**

cpu-protect sub-interface { manage protocol / route } pps	

└───┘

41.3 ARP

41.3.1 arp-guard attack-threshold

arp-guard attack-threshold {per-src-ip | per-src-mac | per-port} pps

per-src-ip	IP
per-src-mac	MAC
per-port	
<i>pps</i>	[1,9999]

IP MAC 8
200

NFPP

Ruijie(config)# ~~show ip arp-guard~~ ~~show ip arp-guard~~

41.3.2 arp-guard enable

ARP

arp-guard enable

-	-

ARP

NFPP

```
Ruijie(config)# nfpp
Ruijie(config-nfpp)# arp-guard enable
```

nfpp arp-guard enable	ARP
show nfpp arp-guard summary	

-	-

41.3.3 arp-guard isolate-period

arp-guard isolate-period {seconds | permanent} , Q A

NFPP

```
Ruijie(config)# nfpp
Ruijie(config-nfpp)# arp-guard isolate-period 180
```

nfpp arp-guard isolate-period	
show nfpp arp-guard summary	

-	-

41.3.4 arp-guard monitor-period

arp-guard monitor-period *seconds*

<i>seconds</i>	[180, 86400]

600

NFPP

```
> 0
0
>
```

```
Ruijie(config)# nfpp
```

```
Ruijie(config-nfpp)# arp-guard monitor-period 180
```

show nfpp arp-guard summary

	-	-

41.3.7 arp-guard scan-threshold

arp-guard scan-threshold *pkt-cnt*

	<i>pkt-cnt</i>	[1,9999]

	15	10
--	----	----

NFPP

10	15	ARP	MAC	IP
	MAC	IP	IP	

```
Ruijie(config)# nfpp
Ruijie(config-nfpp)# arp-guard scan-threshold 20
```

```
nfpp arp-guard scan-threshold
show nfpp arp-guard summary
```

clear nfpp arp-guard hosts [vlan vid] [interface interface-id] [ip-address | mac-address]

<i>vid</i>	
<i>interface-id</i>	
<i>ip-address</i>	IP
<i>mac-address</i>	MAC

└───┘

└───┘

└───┘

└───┘

VLAN 1 g 0/1
 Ruijie# **clear nfpp arp-guard hosts vlan 1 interface g0/1**

arp-guard attack-threshold	
nfpp arp-guard policy	
show nfpp arp-guard hosts	

└───┘

-	-

41.3.9 clear nfpp arp-guard scan

ARP

clear nfpp arp-guard scan

-	-

└───┘

|

|

|

Ruijie# **clear nfpp arp-guard scan**

|

arp-guard scan-threshold	
nfpp arp-guard scan-threshold	
show nfpp arp-guard scan	ARP

|

|

-	-

41.3.10 nfpp arp-guard enable

ARP

nfpp arp-guard enable

|

-	-

|

ARP

|

|

ARP

ARP

|

Ruijie(config)# **interface G0/1**
 Ruijie(config-if)# **nfpp arp-guard enable**

|

arp-guard enable	ARP
show nfpp arp-guard summary	

```

└───┘

```

10.4	

41.3.11 nfpp arp-guard isolate-period

nfpp arp-guard isolate-period {*seconds* | **permanent**}

<i>seconds</i>	0 [30, 86400]
permanent	0

```

└───┘

```

```

└───┘

```

```

└───┘

```

```

Ruijie(config)# interface G 0/1
Ruijie(config-if)# nfpp arp-guard isolate-period 180

```

nfpp arp-guard policy {per-src-ip | per-src-mac | per-port} *rate-limit-pps*
attack-threshold-pps

per-src-ip	IP
per-src-mac	MAC
per-port	
<i>rate-limit-pps</i>	1 9999
<i>attack-threshold-pps</i>	1 9999

```
Ruijie(config)# interface G 0/1
Ruijie(config-if)# nfpp arp-guard policy per-src-ip 2 10
Ruijie(config-if)# nfpp arp-guard policy per-src-mac 3 10
Ruijie(config-if)# nfpp arp-guard policy per-port 50 100
```

arp-guard attack-threshold	
arp-guard rate-limit	
show nfpp arp-guard summary	
show nfpp arp-guard hosts	
clear nfpp arp-guard hosts	

10.4	
------	--

41.3.13 nfpp arp-guard scan-threshold

nfpp arp-guard scan-threshold *pkt-cnt*

<i>pkt-cnt</i>	[1,9999]

	ARP	ARP
--	-----	-----

--	--

--	--

```
Ruijie(config)# interface G 0/1
Ruijie(config-if)# nfpp arp-guard scan-threshold 20
```

arp-guard scan-threshold	
show nfpp arp-guard summary	
show nfpp arp-guard scan	ARP
clear nfpp arp-guard scan	ARP

--	--

10.4	

41.4 DHCP

41.4.1 dhcp-guard attack-threshold

dhcp-guard attack-threshold { per-src-mac | per-port} *pps*

per-src-mac	MAC
per-port	

	<i>pps</i>	[1,9999]
--	------------	----------

	MAC	10	300
--	-----	----	-----

NFPP

```
Ruijie(config)# nfpp
Ruijie(config-nfpp)# dhcp-guard attack-threshold per-src-mac 15
Ruijie(config-nfpp)# dhcp-guard attack-threshold per-port 200
```

	nfpp dhcp-guard policy	
	show nfpp dhcp-guard summary	
	show nfpp dhcp-guard hosts	
	clear nfpp dhcp-guard hosts	

	-	-

41.4.2 dhcp-guard enable

DHCP

dhcp-guard enable

	-	-

DHCP

NFPP

```
Ruijie(config)# nfpp
Ruijie(config-nfpp)# dhcp-guard enable
```

nfpp dhcp-guard enable	DHCP
show nfpp dhcp-guard summary	

-	-

41.4.3 dhcp-guard isolate-period

dhcp-guard isolate-period {seconds | permanent}

<i>seconds</i>	0 [30, 86400]
permanent	0

0

NFPP

```
Ruijie(config)# nfpp
Ruijie(config-nfpp)# dhcp-guard isolate timeout 180
```

nfpp dhcp-guard isolate-period	

	show nfpp dhcp-guard summary	
	-	-

41.4.4 dhcp-guard monitor-period

dhcp-guard monitor- period *seconds*

	<i>seconds</i>	[180, 86400]

600

NFPP

> 0

0

>

```
Ruijie(config)# nfpp
Ruijie(config-nfpp)# dhcp-guard monitor-period 180
```

	show nfpp dhcp-guard summary	
	show nfpp dhcp-guard hosts	
	clear nfpp dhcp-guard hosts	

--	--	--

NFPP

dhcp-guard rate-limit { per-src-mac | per-port} pps

per-src-mac	MAC
per-port	
<i>pps</i>	[1,9999]

	MAC	5	150
--	-----	---	-----

NFPP

```
Ruijie(config)# nfpp
Ruijie(config-nfpp)# dhcp-guard rate-limit per-src-mac 8
Ruijie(config-nfpp)# dhcp-guard rate-limit per-port 100
```

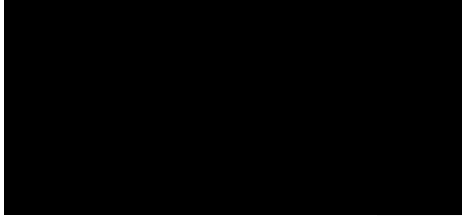

41.4.10 nfpp dhcp-guard policy

nfpp dhcp-guard policy { per-src-mac | per-port} rate-limit-pps attack-threshold-pps

per-src-mac	MAC
per-port	
<i>rate-limit-pps</i>	1 9999
<i>attack-threshold-pps</i>	1 9999

┌

┌

┌

```
Ruijie(config)# interface G 0/1
Ruijie(config-if)# nfpp dhcp-guard policy per-src-mac 3 10
Ruijie(config-if)# nfpp dhcp-guard policy per-port 50 100
```

dhcp-guard attack-threshold	
dhcp-guard rate-limit	
show nfpp dhcp-guard summary	
show nfpp dhcp-guard hosts	
clear nfpp dhcp-guard hosts	

┌

10.4	
------	--

41.5 DHCPv6

41.5.1 dhcpv6-guard attack-threshold

dhcpv6-guard attack-threshold { **per-src-mac** | **per-port** } *pps*

per-src-mac	MAC
per-port	

	-	-

DHCPv6

NFPP

```
Ruijie(config)# nfpp
Ruijie(config-nfpp)# dhcpv6-guard enable
```

nfpp dhcpv6-guard enable		DHCPv6
show nfpp dhcpv6-guard summary		

	10.4	

41.5.3 dhcpv6-guard isolate-period

dhcpv6-guard isolate-period {*seconds* | **permanent**}

<i>seconds</i>	0	[30, 86400]
permanent		

0

NFPP



show nfpp dhcpv6-guard summary	
show nfpp dhcpv6-guard hosts	
clear nfpp dhcpv6-guard hosts	

10.4	

41.5.5 dhcpv6-guard monitored-host-limit

dhcpv6-guard monitored-host-limit *number*

<i>number</i>	1
	4294967295

1000

NFPP

1000 " %ERROR The value that you configured is smaller than current monitored hosts 1000 please clear a part of monitored hosts."

" % NFPP_DHCP_GUARD-4-SESSION_LIMIT: Attempt to exceed limit of 1000 monitored hosts."

Ruijie(config)# **nfpp**
 Ruijie(config-nfpp)# **dhcp-guard monitored-host-limit 200**

show nfpp dhcpv6-guard summary	

clear nfpp dhcpv6-guard hosts [*vlan vid*] [**interface** *interface-id*] [*mac-address*]



|

|

DHCPv6

DHCP

|

```
Ruijie(config)# interface G0/1
Ruijie(config-if)# nfpp dhcpv6-guard enable
```

|

dhcpv6-guard enable	DHCPv6
show nfpp dhcpv6-guard summary	

|

|

	10.4	

41.5.9 nfpp dhcpv6-guard isolate-period

nfpp dhcpv6-guard isolate-period {seconds | permanent}

|

--	--	--

seconds c<17EA35D9>1 Tf 0.0001 Tc 7.1412 T- 2 3198 -0.0 ()Tj ET [30, 86400]0 1 Tf 0 Tc 0 Tw 25.

	dhcpv6-guard isolate-period	
	show nfpp dhcpv6-guard summary	

┌

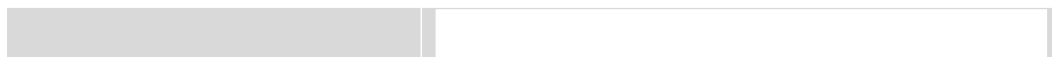

┌

┌

10.4	

41.6 ICMP

41.6.1 icmp-guard attack-threshold

icmp-guard attack-threshold { per-src-ip | per-port} pps

┌

per-src-ip	IP
per-port	
<i>pps</i>	[1,9999]

┌

IP 1200 1500

┌

NFPP

┌

┌

```
Ruijie(config)# nfpp
Ruijie(config-nfpp)# icmp-guard attack-threshold per-src-ip 600
Ruijie(config-nfpp)# icmp-guard attack-threshold per-port 1200
```

┌

nfpp icmp-guard policy	
show nfpp icmp-guard summary	
show nfpp icmp-guard hosts	
clear nfpp icmp-guard hosts	

┌

-	-

41.6.2 icmp-guard enable

ICMP

icmp-guard enable

-	-

ICMP

NFPP

```
Ruijie(config)# nfpp
Ruijie(config-nfpp)# icmp-guard enable
```

nfpp icmp-guard enable	ICMP
show nfpp icmp-guard summary	

-	-

41.6.3 icmp-guard isolate-period

icmp-guard isolate-period {seconds | permanent}

--	--

<i>seconds</i>	0	[30, 86400]
permanent		

0

NFPP

```
Ruijie(config)# nfpp
Ruijie(config-nfpp)# icmp-guard isolate-period 180
```

nfpp icmp-guard isolate-period	
show nfpp icmp-guard summary	

-	-
---	---

41.6.4 icmp-guard monitor-period

icmp-guard monitor-period *seconds*

<i>seconds</i>	[180, 86400]
----------------	--------------

600

NFPP

> 0

|

exceed limit of 1000

monitored hosts."

41.6.8 clear nfpp icmp-guard hosts

clear nfpp icmp-guard hosts [*vlan vid*] [**interface** *interface-id*] [*ip-address*]

<i>vid</i>	
<i>interface-id</i>	
<i>ip-address</i>	IP

└───┘

└───┘

└───┘

```

VLAN 1    g 0/1
Ruijie# clear nfpp icmp-guard hosts vlan 1 interface g 0/1
    
```

icmp-guard attack-threshold	
nfpp icmp-guard policy	
show nfpp icmp-guard hosts	

└───┘

-	-

41.6.9 nfpp icmp-guard enable

ICMP

nfpp icmp-guard enable

|

ICMP

|

|

ICMP

ICMP

|

```
Ruijie(config)# interface G0/1
Ruijie(config-if)# nfpp icmp-guard enable
```

|

icmp-guard enable	ICMP
show nfpp icmp-guard summary	

|

|

10.4	

41.6.10 nfpp icmp-guard isolate-period

nfpp icmp-guard isolate-period {seconds | permanent}

|

seconds	0 [30, 86400]
permanent	0

|

|

|

```
Ruijie(config)# interface G 0/1
Ruijie(config-if)# nfpp
```

|



icmp-guard isolate-period

	clear nfpp icmp-guard hosts	
	10.4	

41.7 ND

41.7.1 nd-guard attack-threshold

nd-guard attack-threshold per-port {ns-na | rs | ra-redirect} pps

	ns-na	
	rs	
	ra-redirect	
	<i>pps</i>	[1,9999]

```

30          /          30
          /          30
    
```

NFPP

```

Ruijie(config)# nfpp
Ruijie(config-nfpp)# nd-guard attack-threshold per-port ns-na 20
Ruijie(config-nfpp)# nd-guard attack-threshold per-port rs 10
Ruijie(config-nfpp)# nd-guard attack-threshold per-port ra-redirect 10
    
```

	nfpp nd-guard policy	

┌

10.4	

41.7.2 nd-guard enable

ND

nd-guard enable

-	-

┌

ND

┌

NFPP

┌

```
Ruijie(config)# nfpf
Ruijie(config-nfpf)# nd-guard enable
```

nfpf nd-guard enable	ND
show nfpf nd-guard summary	

┌

10.4	

41.7.3 nd-guard rate-limit

nd-guard rate-limit per-port { **}**

```

ND

```

```

Ruijie(config)# interface G0/1
Ruijie(config-if)# nfpp nd-guard enable

```

nd-guard enable	ND
show nfpp nd-guard summary	

10.4	

41.7.5 nfpp nd-guard policy

**nfpp nd-guard policy per-port {ns-na | rs | ra-redirect} rate-limit-pps attack-thresh
old-pps**

ns-na	
rs	
ra-redirect	
<i>rate-limit-pps</i>	1 9999
<i>attack-threshold-pps</i>	1 9999

ND snooping

ND snooping

ND snooping

ND guard

800

900

ND guard

ND snooping

ND snooping

```
Ruijie(config)# interface G 0/1
```

```
Ruijie(config-if)# nfpp nd-guard policy per-port ns-na 50 100
```

```
Ruijie(config-if)# nfpp nd-guard policy per-port rs 10 20
```

```
Ruijie(config-if)# nfpp nd-guard policy per-port ra-redirect 10 20
```

```
Ruijie# clear nfpp log
32 log-buffer entries were cleared.
```

show nfpp log	NFPP

10.4	

41.8.2 log-buffer entries

NFPP

log-buffer entries *number*

<i>number</i>	[0,1024]

256

NFPP

```
NFPP 50
Ruijie(config)# nfpp
Ruijie(config-nfpp)# log-buffer entries 50
```

log-buffer logs number_of_message interval length_in_seconds	NFPP
show nfpp log	NFPP

|

|

10.4	

41.8.3 log-buffer logs

NFPP

log-buffer logs *number_of_message interval length_in_seconds*

<i>number_of_message</i>	0-1024 0
<i>length_in_seconds</i>	0-86400 1 0
	<i>number_of_message</i> <i>length_in_seconds</i> 0 <i>number_of_message /length_in_second</i> 0

10.4	

41.8.4 logging

NFPP VLAN

logging vlan *vlan-range*

logging interface *interface-id*

<i>vlan-range</i>	VLAN " 1-3,5"
<i>interface-id</i>	



NFPP



VLAN



VLAN 1 VLAN 2 VLAN 3 VLAN 5

Ruijie(config)# **nfpp**

Ruijie(config-nfpp)# **logging vlan 1-3,5**

G 0/1

Ruijie(config)# **nfpp**

Ruijie(config-nfpp)# **logging interface G 0/1**



show nfpp log summary	NFPP



10.4	

10.4

41.9 ARP

41.9.1 show nfpp arp-guard hosts

show nfpp arp-guard hosts [**statistics** | [[*vlan vid*] [**interface** *interface-id*] [*ip-address* | *mac-address*]]]

statistics	
<i>vid</i>	
<i>interface-id</i>	
<i>ip-address</i>	IP
<i>mac-address</i>	MAC

```

1
Ruijie# show nfpp arp-guard hosts statistics
success  fail  total
-----  ----  -----
100      20    120
          120          100          20

```

```

2          " remain-time(seconds)"
Ruijie# show nfpp arp-guard hosts
If column 1 shows '*', it means "hardware do not isolate user" .
VLAN  interface IP address  MAC address  remain-time(s)
----  -
1     Gi0/1     1.1.1.1     -            110
2     Gi0/2     1.1.2.1     -            61
*3    Gi0/3     -           0000.0000.1111 110

```

```

4      Gi0/4      -      0000.0000.2222  61
Total  4 hosts

```

clear nfpp arp-guard hosts	

-	-

41.9.2 show nfpp arp-guard scan

ARP

show nfpp arp-guard scan [**statistics** | [[**vlan** *vid*] [**interface** *interface-id*] [**ip-address** *s*] [**mac-address**]]]

statistics	ARP
<i>vid</i>	
<i>interface-id</i>	
<i>ip-address</i>	IP
<i>mac-address</i>	MAC

```
Ruijie# show nfpp arp-guard scan statistics
```

```
ARP scan table has 4 record(s).
```

```
    " ARP          4          "
```

```
Ruijie# show nfpp arp-guard scan
```

```
VLAN   interface  IP address  MAC address  timestamp
```

```

-----
1      Gi0/1      N/A      0000.0000.0001  2008-01-23
16:23:10
2      Gi0/2      1.1.1.1  0000.0000.0002  2008-01-23
16:24:10
3      Gi0/3      N/A      0000.0000.0003  2008-01-23
16:25:10
4      Gi0/4      N/A      0000.0000.0004  2008-01-23
16:26:10
Total 4 record(s)

" timestamp"          ARP          " 2008-01-23 16:23:10"
  2008  1  23  16  23  10          ARP
    
```

```

Ruijie# show nfpp arp-guard scan vlan 1 interface G 0/1
0000.0000.0001
VLAN   interface  IP address  MAC address  timestamp
-----
1      Gi0/1      N/A        0000.0000.0001  2008-01-23
16:23:10
Total 1 record(s)
    
```

arp-guard scan-threshold	
nfpp arp-guard scan-threshold	
clear nfpp arp-guard scan	ARP

-	-

41.9.3 show nfpp arp-guard summary

show nfpp arp-guard summary

-	-

```
Ruijie# show nfpp arp-guard summary
```

```
Format of column Rate-limit and Attack-threshold is per-src-ip
/per-src-mac/per-port.
```

Interface	Status	Isolate-period	Rate-limit	Attack-threshold	Scan-threshold
Global	Enable	300	4/5/60	8/10/100	15
Gi 0/1	Enable	180	5/-/-	8/-/-	-
Gi 0/2	Disable	200	4/5/60	8/10/100	20

```
Maximum count of monitored hosts: 1000
```

```
Monitor period 300s
```

- 1 Interface Global
- 2 Status
- 3 Rate-limit IP / MAC
- / Attack-threshold " -"

arp-guard attack-threshold	
arp-guard enable	ARP
arp-guard isolate-period	
arp-guard monitor-period	
arp-guard monitored-host-limit	
arp-guard rate-limit	
arp-guard scan-threshold	
nfpp arp-guard enable	ARP
nfpp arp-guard isolate-period	

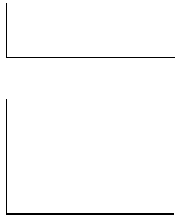

-	-

41.10 DHCP

41.10.1 show nfpp dhcp-guard hosts

show nfpp dhcp-guard hosts [**statistics** | [[**vlan** *vid*] [**interface** *interface-id*] [*mac-address*]]]

statistics	
<i>vid</i>	
<i>interface-id</i>	
<i>mac-address</i>	MAC

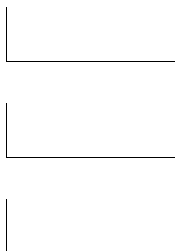

Ruijie# **show nfpp dhcp-guard hosts statistics**

```

success   fail   total
-----   ----   -----
100        20     120
           120           100           20
    
```

" remain-time(seconds)"

Ruijie# **show nfpp dhcp-guard hosts**

If column 1 shows '*', it means "hardware failed to isolate host".

VLAN interface MAC address remain-time(seconds)

```

-----
1    gi0/2    0000.0000.0001    10
*2   gi0/1    0000.0000.0002    20
Total 2 host(s)

```

clear nfpp dhcp-guard hosts	

10.4	

41.10.2 show nfpp dhcp-guard summary

show nfpp dhcp-guard summary

-	-

```
Ruijie# show nfpp dhcp-guard summary
```

```

Format of column Rate-limit and Attack-threshold is per-src-ip
/per-src-mac/per-port.

```

Interface	Status	Isolate-period	Rate-limit	Attack-threshold
Global	Enable	300	-/5/150	-/10/300
Gi 0/1	Enable	180	-/6/-	-/8/-
Gi 0/2	Disable	200	-/5/30	-/10/50

```
Maximum count of monitored hosts: 1000
```

```
Monitor period 300s
```

```

1      Interface  Global
2      Status
3      Rate-limit          IP          /      MAC
/          Attack-threshold          "  _"
    
```

dhcp-guard attack-threshold	
dhcp-guard enable	DHCP
dhcp-guard isolate-period	
dhcp-guard monitor-period	
dhcp-guard monitored-host-limit	
dhcp-guard rate-limit	
nfpp dhcp-guard enable	DHCP
nfpp dhcp-guard isolate-period	
nfpp dhcp-guard policy	

10.4	

41.11 DHCPv6

41.11.1 show nfpp dhcpv6-guard hosts

show nfpp dhcpv6-guard hosts [**statistics** | [[**vlan** *vid*] [**interface** *interface-id*

<i>mac-address</i>	MAC
--------------------	-----

Ruijie# **show nfpp dhcpv6-guard hosts statistics**

```

success   fail   total
-----   ---   -----
100         20     120
          120         100         20
  
```

" remain-time(seconds)"

Ruijie# **show nfpp dhcpv6-guard hosts**

If column 1 shows '*', it means "hardware failed to isolate host".

```

VLAN  interface  MAC address  remain-time(seconds)
----  -
1     gi0/2      0000.0000.0001  10
*2    gi0/1      0000.0000.0002  20
Total 2 host(s)
  
```

-	-

Ruijie# **show nfpp dhcpv6-guard summary**

Format of column Rate-limit and Attack-threshold is per-src-ip /per-src-mac/per-port.

Interface	Status	Isolate-period	Rate-limit	Attack-threshold
Global	Enable	300	-/5/150	-/10/300
Gi 0/1	Enable	180	-/6/-	-/8/-
Gi 0/2	Disable	200	-/5/30	-/10/50

Maximum count of monitored hosts: 1000

Monitor period 300s

- 1 Interface Global
- 2 Status
- 3 Rate-limit IP / MAC
- / Attack-threshold " -"



	10.4	

41.12 ICMP

41.12.1 show nfpp icmp-guard hosts

```

2      Gi0/2      1.1.2.1      61
Total  2 host(s)

```

clear nfpp icmp-guard hosts	

10.4	

41.12.2 show nfpp icmp-guard summary

show nfpp icmp-guard summary

-	-

```
Ruijie# show nfpp icmp-guard summary
```

```

Format of column Rate-limit and Attack-threshold is per-src-ip
/per-src-mac/per-port.

```

Interface	Status	Isolate-period	Rate-limit	Attack-threshold
Global	Enable	300	4/-/60	8/-/100
Gi 0/1	Enable	180	5/-/-	8/-/-
Gi 0/2	Disable	200	4/-/60	8/-/100

```
Maximum count of monitored hosts: 1000
```

```
Monitor period 300s
```

```
1      Interface  Global
```

```

2      Status
3      Rate-limit          IP          /      MAC          /
                        Attack-threshold      " _"
    
```

icmp-guard attack-threshold	
icmp-guard enable	ICMP
icmp-guard isolate-period	
icmp-guard monitor-period	
icmp-guard monitored-host-limit	
icmp-guard rate-limit	
nfpp icmp-guard enable	ICMP
nfpp icmp-guard isolate-period	
nfpp icmp-guard policy	

10.4	

41.12.3 show nfpp icmp-guard trusted-host

show nfpp icmp-guard trusted-host

-	-

```
Ruijie# show nfpp icmp-guard trusted-host
IP address      mask
-----
1.1.1.0         255.255.255.0
```

```

Gi 0/1      Enable 15/15/15  30/30/30
Gi 0/2      Disable -/5/30   -/10/50
    
```

```

1      Interface  Global
2      Status
3      Rate-limit          /          /
      /          /          Attack-threshold
      " -"
      " -/5/30"          G 0/2          /
      5          /          30
    
```

nd-guard attack-threshold	
nd-guard enable	ND
nd-guard rate-limit	
nfpp nd-guard enable	ND
nfpp nd-guard policy	

--	--

42 ACL

id	IP ACL 1-99 1300-1999 IP ACL 100-199 2000-2699 MAC ACL 700-799 ACL 2700-2899
name	ACL
sn	ACL ()
start-sn	
inc-sn	
deny	
permit	
prot	IPv6 ipv6 icmp tcp udp 0-255 IPv4 eigrp gre ipinip igmp nos ospf icmp udp

precedence precedence	0-7
range	
time-range tm-rng-name	tm-rng-name
tos tos	0-15
cos cos	cos (0-7)
cos inner cos	tag cos
icmp-type	ICMP 0-255
icmp-code	ICMP 0-255
icmp-message	ICMP
operator port[port]	Operator lt- eq- gt- neq- range- port

B	MAC	6	P		35
C		12	Q	IP	36
D	VLAN tag	14	R	ip	38
E	DSAP()	18	S	ip	42
F	SSAP()	19	T	TCP	46
G	Ctrl	20	U	TCP	48
H	Org Code	21	V		50
I					

4) Expert 2700 - 2899

access-list *id* {deny | permit} [protocol | [ethernet-type][cos [out][inner in]]] [VID [out][inner in]] {source source-wildcard | host source | any} {host source-mac-address | any} {destination destination-wildcard | host destination | any} {host destination-mac-address | any} [[precedence precedence] [tos tos] [fragments] [range lower upper] [time-range time-range-name]

> Ethernet-type cos

access-list *id* {deny | permit} {ethernet-type} cos [out][inner in]] [VID [out][inner in]] {source source-wildcard | host source | any} {host source-mac-address | any } {destination destination-wildcard | host destination | any} {host destination-mac-address | any} [time-range time-range-name]

> Protocol

access-list *id* {deny | permit} protocol [VID [out][inner in]] {source source-wildcard | host source | any} {host source-mac-address | any } {destination destination-wildcard | host destination | any} {host destination-mac-address | any} [precedence precedence] [tos tos] [fragments] [range lower upper] [time-range time-range-name]

> Expert

Internet Control Message Protocol (ICMP)

access-list *id* {deny | permit} icmp [VID [out][inner in]] {source source-wildcard | host source | any} {host source-mac-address | any } {destination destination-wildcard | host destination | any} {host destination-mac-address | any} [icmp-type] [[icmp-type [icmp-code]] | [icmp-message]] [precedence precedence] [tos tos] [fragments] [time-range time-range-name]

Transmission Control Protocol (TCP)

access-list *id* {deny | permit} tcp [VID [out][inner in]] {source source-wildcard | host Source | any} {host source-mac-address | any } [operator port [port]] {destination destination-wildcard | host destination | any} {host destination-mac-address | any} [operator port [port]] [precedence precedence] [tos tos] [fragments] [range lower upper] [time-range time-range-name] [match-all tcp-flag]

User Datagram Protocol (UDP)

access-list *id* {deny | permit} udp [VID [out][inner in]] {source source-wildcard | host source | any} {host source-mac-address | any } [operator port [port]] {destination destination-wildcard | host destination | any} {host destination-mac-address | any} [operator port [port]] [precedence precedence] [tos tos] [fragments] [range lower upper] [time-range time-range-name]

5)

access-list *list-remark text*

<i>Id</i>	1-99 100-199 1300-1999 2000-2699 2700 – 2899 700 - 799
Deny	
Permit	
<i>Source</i>	
<i>source-wildcard</i>	0.255.0.32
<i>protocol</i>	IP EIGRP GRE IPINIP IGMP NOS OSPF ICMP UDP TCP IP IP 0-255 ICMP/TCP/UDP
<i>Destination</i>	
<i>destination-wildcard</i>	0.255.0.32
fragments	

precedence 0.0 Tc 0.98<01C3D9.4SPF XE\$

match-all	<i>tcp flag</i>
<i>tcp-flag</i>	tcp flag

┌
└

ACL

┌
└

access-list

- › dod-host-prohibited
- › dod-net-prohibited
- › echo
- › echo-reply
- › fragment-time-exceeded
- › general-parameter-problem
- › host-isolated
- › host-precedence-unreachable
- › host-redirect
- › host-tos-redirect
- › host-tos-unreachable
- › host-unknown
- › host-unreachable
- › information-reply
- › information-request
- › mask-reply
- › mask-request
- › mobile-redirect
- › net-redirect
- › net-tos-redirect
- › net-tos-unreachable
- › net-unreachable
- › network-unknown
- › no-room-for-option
- › option-missing
- › packet-too-big
- › parameter-problem
- › port-unreachable
- › precedence-unreachable
- › protocol-unreachable
- › redirect
- › router-advertisement
- › router-solicitation
- › source-quench
- › source-route-failed
- › time-exceeded
- › timestamp-reply
- › timestamp-request

```
>  ttl-exceeded
>  unreachable
    TCP          TCP
>  bgp
>  chargen
>  cmd
>  daytime
>  discard
>  domain
>  echo
>  exec
>  finger
>  ftp
>  ftp-data
>  gopher
>  hostname
>  ident
>  irc
>  klogin
>  kshell
>  login
>  nntp
>  pim-auto-rp
>  pop2
>  pop3
>  smtp
>  sunrpc
>  syslog
>  tacacs
>  talk
>  telnet
>  time
>  uucp
>  whois
>  www
    UDP          UDP
>  biff
>  bootpc
```

- › bootps
- › discard
- › dnsix
- › domain
- › echo
- › isakmp
- › mobile-ip
- › nameserver
- › netbios-dgm
- › netbios-ns
- › netbios-ss
- › ntp
- › pim-auto-rp
- › rip
- › snmp
- › snmptrap
- › sunrpc
- › syslog
- › tacacs
- › talk
- › tftp
- › time
- › who
- › xdmcp

Ethernet-type

- › aarp
- › arp
- › appletalk
- › decnet-iv
- › diagnostic
- › etype-6000
- › etype-8042
- › lat
- › lavc-sca
- › mop-console
- › mop-dump
- › mumps
- › netbios

- > vines-echo
- > xns-idp

```
1 IP
   IP          192.168.1.64 - 192.168.1.127
```

```
Ruijie(config)# access-list 1 permit 192.168.1.64 0.0.0.63
```

```
2 IP
   IP          DNS      ICMP
```

```
Ruijie(config)# access-list 102 permit tcp any any eq domain
```

```
Ruijie(config)# access-list 102 permit udp any any eq domain
```

```
Ruijie(config)# access-list 102 permit icmp any any echo
```

```
Ruijie(config)# access-list 102 permit icmp any any echo-reply
```

```
3 MAC
   MAC 00d0f8000c0c          100
```

destination-wildcard | **host** *destination* | **any** {**host** *destination-mac-address* | **any**}
[time-range *time-range-name*]

b) *protocol*

[*sn*] **deny protocol** [[**VID** [*out*][*inner in*]]] {*source source-wildcard* | **host source** | **any**}
 {**host source-mac-address** | **any**} {*destination destination-wildcard* | **host destination** | **any**}
 {**host destination-mac-address** | **any**} [**precedence precedence**] [**tos tos**] [**fragments**]
[range *lower upper*] [**time-range** *name*]

c) *expert*

> **Internet Control Message Protocol (ICMP)**

[*sn*] **deny icmp** [[**VID** [*out*][*inner in*]]] {*source source-wildcard* | **host source** | **any**} {**host**
source-mac-address | **any**} {*destination destination-wildcard* | **host destination** | **any**} {**host**
destination-mac-address | **any**} [*icmp-type*] [[*icmp-type icmp-code*]] | [*icmp-message*]]
[precedence precedence] [**tos tos**] [**frag-6()**]931 Tf0(upper)c 0 Tw 2.571 0 Td[(icmp)-65 Tf2BE3C02D6>T/TT0 1 Tf

[[*icmp-type* [*icmp-code*]] | [*icmp-message*]] [**dscp** *dscp*] [**flow-label** *flow-label*] [**fragments**] [**time-range** *time-range-name*]

› **Transmission Control Protocol (TCP)**

[*sn*] **deny tcp** {*source-ipv6-prefix* / *prefix-length* | **host** *source-ipv6-address* | **any**}[*operator* **port**[*port*]] {*destination-ipv6-prefix* /*prefix-length* | **host** *destination-ipv6-address* | **any**} [*operator* **port** [*port*]] [**dscp** *dscp*] [**flow-label** *flow-label*] [**fragments**] [**range** *lower upper*] [**time-range** *time-range-name*] [**match-all** *tcp-flag*]

› **User Datagram Protocol (UDP)**

[*sn*] **deny udp** {*source-ipv6-prefix/prefix-length* | **host** *source-ipv6-address* | **any**} [*operator* **port** [*port*]] {*destination-ipv6-prefix* /*prefix-length* | **host** *destination-ipv6-address* | **any**}[*operator* **port** [*port*]] [**dscp** *dscp*] [**flow-label** *flow-label*] [**fragments**] [**range** *lower upper*] [**time-range** *time-range-name*]

<i>Sn</i>	ACL
<i>source-ipv6-prefix</i>	IPv6
<i>destination-ipv6-prefix</i>	IPv6
<i>prefix-length</i>	
<i>source-ipv6-address</i>	IPv6
<i>destination-ipv6-address</i>	IPv6
dscp	
<i>dscp</i>	0-63.
flow-label	
<i>flow-label</i>	0-1048575
<i>protocol</i>	IPV6 <0-255> IPV6 icmp tcp udp

1

```
Ruijie(config)# ipv6 access-list extended v6-acl
Ruijie(config-ipv6-nacl)# 11 deny ipv6 host 192.168.4.12 any
Ruijie(config-ipv6-nacl)# show access-lists
ipv6 access-list extended v6-acl
11 deny ipv6 host 192.168.4.12 any
Ruijie(config-ipv6-nacl)# exit
Ruijie(config)# interface gigabitethernet 1/1
Ruijie(config-if)# ipv6 traffic-filter v6-acl in
```

show access-lists	
ipv6 traffic-filter	IPV6
ip access-group	IP ACL
mac access-group	MAC ACL
ip access-list	IP ACL
mac access-list	MAC ACL
expert access-list	ACL
ipv6 access-list	IPV6 ACL
permit	

V10.0	V10.0 arp V10.2(3)
-------	-----------------------

42.1.3 expert access-group

EXPERT ACL

no

expert access-group {id | name} {in | out}

no expert access-group {id | name} {in | out}

<i>id</i>	Expert	2700-2899
<i>name</i>	Expert	

ACL

show expert access-lists

```

1          ACL
Ruijie(config)# expert access-list extended exp-acl
Ruijie(config-exp-nacl)# show expert access-lists
expert access-list extended exp-acl
Ruijie(config-exp-nacl)#

2          ACL
Ruijie(config)# expert access-list extended 2704
Ruijie(config-exp-nacl)# show expert access-lists
expert access-list extended 2704
Ruijie(config-exp-nacl)#
    
```

show expert access-lists	

V10.0	V10.0

42.1.5 ip access-group

ip access-group no

ip access-group {*id* | *name*} {**in** | **out**}

no ip access-group { *id* | *name*} {**in** | **out**}

<i>id</i>	IP 1-199 1300-2699
<i>name</i>	IP
in	
out	

ip access-group

fastEthernet0/0 120

Ruijie(config)# **interface fastEthernet 0/0**

Ruijie(config-if)#**ip access-group 120 in**

access-list	
show access-lists	
show ip access-list	IP 1-199 1300 - 2699 3000 3199

```

1      ACL
Ruijie(config)# ip access-list standard std-acl
Ruijie(config-std-nacl)# show ip access-lists
ip access-list standard std-acl
Ruijie(config-std-nacl)#

2      ACL
Ruijie(config)# ip access-list extended 123
Ruijie(config-ext-nacl)# show ip access-lists
ip access-list extended 123
    
```

show ip access-lists	IP

V10.0	V10.0

42.1.7 ip access-list resequence

```

ip      ACL          IPV6    ACL
no
    
```

ip access-list resequence {id | name} start-sn inc-sn

no ip access-list resequence {id | name}

<i>id</i>	ACL
<i>name</i>	ACL
<i>start-sn</i>	
<i>inc-sn</i>	

```

start-sn 10
inc-sn 10
    
```



show access-lists

ACL
Ruijie#

|

|

ACL
traffic-filter

show ipv6

|

```

access-list v6-acl Gigabit 1
Ruijie(config)# interface GigaEthernet 0/1
Ruijie(config-if)# ipv6 traffic-filter v6-acl in
    
```

|

show access-group	ACL

|

|

V10.0	V10.0

42.1.9 ipv6 access-list

|

IPV6 ACL

no

ACL

ipv6 access-list *name*

no ipv6 access-list *name*

|

<i>name</i>	ACL

|

|

|

show access-lists

|

```

IPV6 ACL
Ruijie(config)# ipv6 access-list v6-acl
Ruijie(config-ipv6-nacl)# show access-lists
ipv6 access-list extended v6-acl
Ruijie(config-ipv6-nacl)#
    
```

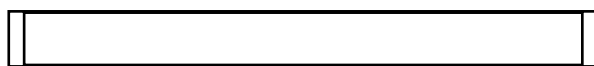



V10.0	V10.0

42.1.11 MAC access-group

MAC ACL

no

mac access-group {*id* | *name*}{**in** | **out**}

no mac access-group {*id* | *name*} {**in** | **out**}

<i>id</i>	MAC 700-799
<i>name</i>	MAC
in	
out	

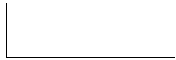

ACL



show running-config

```

access-list accept_00d0f8xxxxx_only Gigabit 1
Ruijie(config)# interface GigaEthernet 1/1
Ruijie(config-if)# mac access-group accept_00d0f8xxxxx_only in
    
```

--	--

show access-group

ACL

MAC ACL

no

ACL

mac access-list extended {*id* | *name*}

no mac access-list extended {*id* | *name*}

<i>id</i>	MAC	700-799
<i>name</i>	MAC	

MAC ACL

show mac access-lists

1 MAC ACL

Ruijie(config)# **mac access-list extended** *mac-acl*

Ruijie(config-mac-nacl)# **show mac access-lists**

mac access-list extended *mac-acl*

2 MAC ACL

Ruijie(config)# **mac access-list extended** 704

Ruijie(config-mac-nacl)# **show mac access-lists**

mac access-list extended 704

show mac access-lists	mac

V10.0	V10.0

42.1.13 no sn

ACL

no *sn*

--	--

<i>sn</i>	ACL
-----------	-----

ACL

ACL

ACL

```
Ruijie(config)# ipv6 access-list extended v6-acl
Ruijie(config-ipv6-nacl)# permit ipv6 host ::192.168.4.12 any
Ruijie(config-ipv6-nacl)# 12 deny ipv6 host any any
Ruijie(config-ipv6-nacl)# show access-lists
ipv6 access-list extended v6-acl
10 permit ipv6 host ::192.168.4.12 any
12 deny ipv6 any any
Ruijie(config-ipv6-nacl)# no 12
Ruijie(config-ipv6-nacl)# show access-lists
ipv6 access-list extended v6-acl
10 permit ipv6 host ::192.168.4.12 any
Ruijie(config-ipv6-nacl)#
```

[sn] **permit protocol** [VID [out][inner in]] {source source-wildcard | **host** Source | **any**} {**host** source-mac-address | **any**} {destination destination-wildcard | **host** destination | **any**} {**host** destination-mac-address | **any**} [precedence precedence] [tos tos] [fragments] [range lower upper] [time-range time-range-name]

Expert

› **Internet Control Message Protocol (ICMP)**

[sn] **permit icmp** [VID [out][inner in]] {source source-wildcard | **host** source | **any**} {**host** source-mac-address | **any**} {destination destination-wildcard | **host** destination | **any**} {**host** destination-mac-address | **any**} [icmp-type] [[icmp-type [icmp-code]] | [icmp-message]] [precedence precedence] [tos tos] [fragments] [time-range time-range-name]

› **Transmission Control Protocol (TCP)**

[sn] **permit tcp** [VID [out][inner in]] {source source-wildcard | **host** Source | **any**} {**host** source-mac-address | **any**} [operator port [port]] {destination destination-wildcard | **host** destination | **any**} {**host** destination-mac-address | **any**} [operator port [port]] [precedence precedence] [tos tos] [fragments] [range lower upper] [time-range time-range-name] [match-all tcp-flag]

› **User Datagram Protocol (UDP)**

[sn] **permit udp** [VID [out][inner in]] {source source-wildcard | **host** source | **any**} {**host** source-mac-address | **any**} [operator port [port]] {destination destination-wildcard | **host** destination | **any**} {**host** destination-mac-address | **any**} [operator port [port]] [precedenceprecedence] [tos tos] [fragments] [range lower upper] [time-range time-range-name]

› **Address Resolution Protocol (ARP)**

[sn] **permit arp** {vid vlan-id} [host source-mac-address | **any**] [host destination-mac-address | **any**] {sender-ip sender-ip-wildcard | **host** sender-ip | **any**} {sender-mac sender-mac-wildcard | **host** sender-mac | **any**} {target-ip target-ip-wildcard | **host** target-ip | **any**}

5) IPV6

[sn] **permit protocol** {source-ipv6-prefix / prefix-length | **any** | **host** source-ipv6-address} {destination-ipv6-prefix / prefix-length | **any**} {hostdestination-ipv6-address} [dscp dscp] [flow-label flow-label] [fragments] [range lower upper] [time-range time-range-name]

IPV6

› **Internet Control Message Protocol (ICMP)**

[sn] **permit icmp** {source-ipv6-prefix / prefix-length | **any** source-ipv6-address | **host**} {destination-ipv6-prefix / prefix-length | **host** destination-ipv6-address | **any**} [icmp-type] [[icmp-type [icmp-code]] | [icmp-message]] [dscp dscp] [flow-label flow-label][fragments] [time-range time-range-name]

› **Transmission Control Protocol (TCP)**

[sn] **permit tcp** {*source-ipv6-prefix / prefix-length* | **host** *source-ipv6-address* | **any**}
[*operator* **port** [*port*]] {*destination-ipv6-prefix / prefix-length* | **host** *destination-ipv6-address*
| **any**} [*operator* **port** [*port*]] [**dscp** *dscp*] [**flow-label** *flow-label*] [**fragments**] [**range** *lower*
upper] [**time-range** *time-range-name*] [**match-all** *tcp-flag*]

› **User Datagram Protocol (UDP)**

[sn] **permit udp** {*source-ipv6-prefix / prefix-length* | **host** *source-ipv6-address* | **any**}
[*operator* **port** [*port*]] {*destination-ipv6-prefix / prefix-length* | **host** *destination-ipv6-address*
| **any**} [*operator* **port** [*port*]] [**dscp** *dscp*] [**flow-label** *flow-label*] [**fragments**] [**range** *lower*
upper] [**time-range** *time-range-name*]



```
Ruijie(config)# interface gigabitethernet 1/1
Ruijie(config-if)# ip access-group 102 in
Ruijie(config-if)#
      3      MAC      ACL      MAC      0013.0049.8272
      100      1
Ruijie(config)# mac access-list extended 702
Ruijie(config-mac-nacl)# permit host 0013.0049.8272 any aarp
Ruijie(config-mac-nacl)# show access-lists
mac access-list extended
10 permit host 0013.0049.8272 any aarp702
Ruijie(config-mac-nacl)# exit
Ruijie(config)# interface gigabitethernet 1/1
Ruijie(config-if)# mac access-group 702 in
      4      ip      ACL      IP      192.168.4.12
      1
Ruijie(config)# ip access-list standard std-acl
Ruijie(config-std-nacl)# permit host 192.168.4.12
Ruijie(config-std-nacl)# show access-lists
ip access-list standard std-acl
10 permit host 192.168.4.12
Ruijie(config-std-nacl)# exit
Ruijie(config)# interface gigabitethernet 1/1
Ruijie(config-if)# ip access-group std-acl in
      5      IPV6      ACL      IP      192.168.4.12
      1
Ruijie(config)# ipv6 access-list extended v6-acl
Ruijie(config-ipv6-nacl)# 11 permit ipv6
host ::192.168.4.12 any
Ruijie(config-ipv6-nacl)# show access-lists
ipv6 access-list extended v6-acl
11 permit ipv6 host ::192.168.4.12 any
Ruijie(config)# interface gigabitethernet
```

ip access-group	IP ACL
mac access-group	MAC ACL
ip access-list	IP ACL
mac access-list	MAC ACL
expert access-list	ACL
ipv6 access-list	IPV6 ACL
deny	ACL

V10.0	V10.0 arp V10.2(3)

42.2

42.2.1 show access-group

ACL

show access-group [interface <interface>]

<interface>	

ACL

ACL

```
Ruijie# show access-group
ip access-list standard ipstd3
Applied On interface GigabitEthernet 0/1.
ip access-list standard ipstd4
Applied On interface GigabitEthernet 0/2.
ip access-list extended 101
```

```
Applied On interface GigabitEthernet 0/3.
ip access-list extended 102
Applied On interface GigabitEthernet 0/8.
```

ip access-group	ip
mac access-group	MAC
expert access-group	Expert
ipv6 traffic-filter	IPV6

V10.0	V10.0

42.2.2 show access-lists

ACL ACL

show access-lists [*id* | *name*]

<i>id</i>	
<i>name</i>	

acl *id* *name* ACL

```
Ruijie# show access-lists n_acl
ip access-list standard n_acl
Ruijie# show access-lists 102
ip access-list extended 102
Ruijie# show access-lists
ip access-list standard n_acl
```

ACL

	V10.0

group

CL

o[interface <interface>]

IP ACL

IP ACL

```

>w ip access-group interface gigabitethernet 0/1
group aaa in
interface GigabitEthernet 0/1.

```

	IP ACL



	<i><interface></i>	

|

|

|

IPv6 ACL

IPv6 ACL

|

```
Ruijie# show ipv6 traffic-filter interface gigabitethernet 0/4  
ipv6 traffic-filter v6 in  
Applied On interface GigabitEthernet 0/4.
```

|

--	--	--

```
mac access-group mm in
Applied On interface GigabitEthernet 0/3.
```

mac access-list	MAC ACL

V10.0	V10.0

42.3

42.3.1 security access-group

security access-group {*id*|*name*}

no security access-group

<i>id</i>	ACL id
<i>name</i>	ACL

```
Ruijie(config-if)#security access-group 1
```

show secu-acl	

	V10.2	V10.2

42.3.2 security global access-group

security global access-group {*id*|*name*}

no security global access-group

--	--	--

Fa0/6 uplink --

security global access-group	
security access-group	
security uplink enable	

V10.2	V10.2

43 VACL

43.1

	Vlan access map		<i>map_name</i>		<i>map_sn</i>	
			map		map	
1	vlan access map		map		<i>map_sn</i>	
	map		map	map	<i>map_sn</i>	10
2		<i>map_sn</i>	vlan access map		<i>map_name</i>	
	<i>Map_name</i>		map			
3		<i>map_sn</i>	vlan access map		map	
	map	map	map	map		
4		map	6553	map		

no action redirect{GigabitEthernet | Aggregateport | FastEthernet } {*port_id*}



<i>acl_id</i>	numbered acl;
---------------	---------------

Config-access-map vacl

+	acl,	8	acl
>	map	ip acl	map acl
>	map	8	acl
>	map		acl
>	map	ace	acl acl
>	map		ip acl (mac acl)
	ip acl (mac acl)		ip acl (mac acl)
	ip acl (mac acl)		
>	map		ip acl (mac acl)
	mac acl (ip acl)		ip acl (mac
	acl) mac acl (ip acl)		

map match

```
Ruijie(config)# vlan access-map dd
Ruijie(config-access-map)# match ip address 10 20 sp1 30 sp2
Ruijie(config-access-map)# exit
Ruijie(config)# vlan access-map dd 20
Ruijie(config-access-map)# match mac address 710 720 m1 760
Ruijie(config-access-map)# exit
Ruijie(config)#
```

Ip@S\$òDf0C@!0&5e!D!sVX9OfD!ç^NE# %AbE!pDf0R

VACL

<i>map_name</i>	map
<i>vlan_id</i>	vlan id

┌

┌

```

vlan access map      vlan          vlan          vlan
filter aa vlan-list 1-33  map      1-33      vlan
    
```

```

map ff vlan access map      vlan 5
Ruijie(config)# vlan filter ff vlan-list 5
    
```

-	-

┌

-	-

43.2

43.2.1 show vlan access map

```

map
show vlan access map
map
show vlan access map map_name
    
```



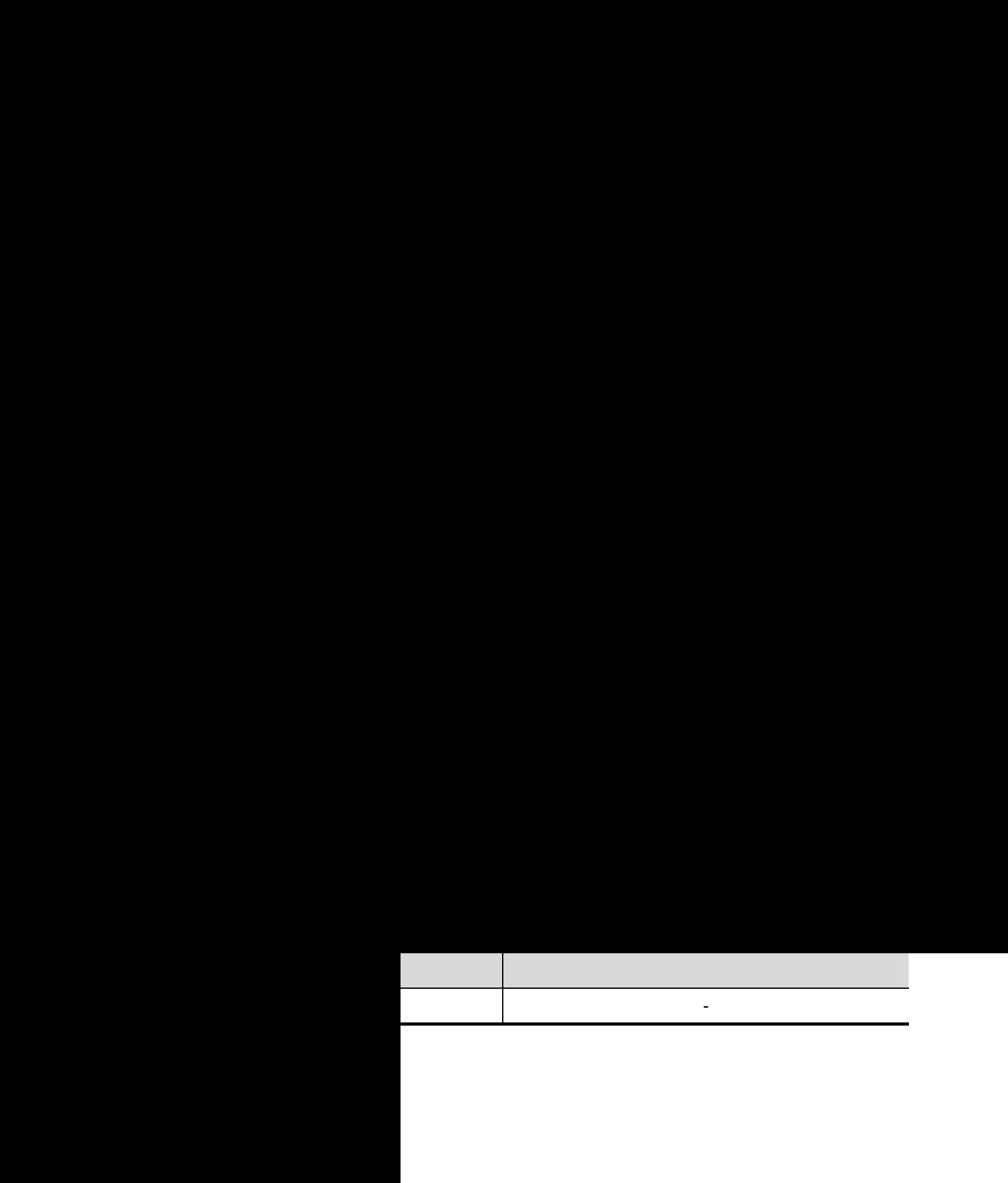

	-

f [redacted] 0.64 re11ef1452 g147..36 354.8 209.22 19.62 ref0 gBT/C2_0 1 Tf0

|

|

|

|

Show vlan filter access-map aa

```
Ruijie(config)# show vlan filter
VLAN Map aa
Configured on VLANs: 1, 5, 6,
Ruijie(config)#
```

|

show vlan filter access-map map_name	map vlan
show vlan filter vlan vlan_id	map vlan

|

|

-	-

44 QOS

44.1

```

QoS
>
> policy-map
> class-map
> class-map 1 ACL ACL ACE
> ACE "ACL"

```

```

QoS Policy Map
QoS QoS Policy Map Off
QoS QOS

```

CoS	0
	8
	WRR
QueueWeight	1:1:1:1:1:1:1
WRR Weight Range	1:15
DRR Weight Range	1:15
	No Trust

Cos

CoS 2264.2T0 16(CoS)T/t 0.48 .1s026- 15 135.3646 2844 -19. 0 TdW0.852 g141.6

CoS to DSCP	CoS	DSCP
	0	0
	1	8
	2	16
	3	24
	4	32
	5	40
	6	48
	7	56

IP-Precedence to DSCP

IP-Precedence to DSCP	IP-Precedence	DSCP
	0	0
	1	8
	2	16
	3	24
	4	32
	5	40
	6	48
	7	56

DSCP to CoS

DSCP to CoS	DSCP	CoS
	0	0
	8	1
	16	2
	24	3
	32	4
	40	5
	48	6
	56	7

44.2

44.2.1 class maps

ACL

ip access-list {**extended** | **standard**} { *acl-id* | *acl-name* }

mac access-list extended {*acl-id* | *acl-name*}

expert access-list extended {*acl-id* | *acl-name*}

ipv6 access-list extended *acl-name*

```

4      class-map,   cm
Ruijie(config)# class-map cm
5      ACL
Ruijie(config-cmap)# match access-group me
6      class-map
Ruijie(config-cmap)# exit
    
```

show mac access-lists	-
show ip access-lists	-
show class-map	-

-	-

44.2.2 drr-queue bandwidth

DRR

drr-queue bandwidth *weight1...weight8*

no drr-queue bandwidth

<i>weight1...weight8</i>	
no	

```

Ruijie(config)# drr-queue bandwidth 1 2 3 4 5 6 7 8
    
```

--	--

	show mls qos queueing	-
	-	-

	-	-
--	---	---

44.2.4 mls qos cos

CoS

mls qos cos *default-cos*

no mls qos cos

<i>default-cos</i>		0 7
no		

CoS 0

└───

└───

```
Ruijie(config)# interface gigabitethernet 1/1
Ruijie(config-if)# mls qos cos 7
```



	dscp	
	no	

|

|

|

| Ruijie(config)# **mls qos map cos-dscp 8 10 16 18 24 26 32 34**

```
Ruijie(config)# mls qos map dscp-cos 8 10 16 18 to 0
```

-	-

```
show mls qos maps dscp-cos maps,dscp-cos maps ip-prec-dscp maps
```

-	-

44.2.7 mls qos map ip-prec-dscp

ippre DSCP

mls qos map ip-prec-dscp dscp1...dscp8

no mls qos map ip-prec-dscp

dscp	
no	

```
Ruijie(config)# mls qo map ip-prec -dscp 8 10 16 18 24 26 32 34
```

--	--

```
show mls qos maps dscp-cos maps,dscp-cos maps ip-prec-dscp maps
```

44.2.8 mls qos scheduler

mls qos scheduler [sp | rr | wrr | drr]

no mls qos scheduler

sp	
rr	
wrr	
drr	
no	

wrr

Ruijie(config)# **mls qos scheduler sp**

cos	Qos	CoS
dscp	Qos	DSCP
<i>ip-precedence</i>	Qos	IP-PRE
no		

|

|

|

```
Ruijie(config)# interface gigabitethernet 1/1
Ruijie(config-if)# mls qos trust cos
```

--	--

no policy-map <i>policy-map-name</i>	policy map
<i>class-map-name</i>	class map
no class <i>class-map-name</i>	
<i>new-dscp</i>	DSCP
<i>rate-bps</i>	kbps
<i>burst-byte</i>	kbyte
<i>drop</i>	
<i>dscp-value</i>	DSCP

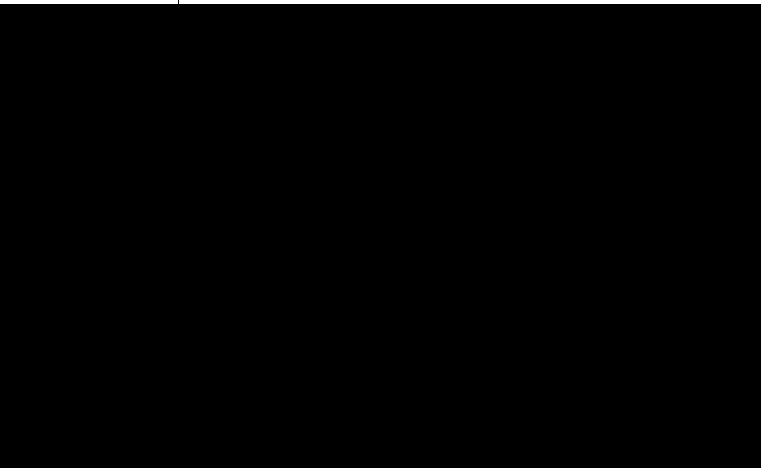

map po

ass cm

```
Ruijie(config-pmap-c)# set ip dscp 10
4 1M, 4096k, dscp 16
Ruijie(config-pmap-c)# police 1000000 4096 exceed-action dscp 16
```



priority-queue	SP
no priority-queue	WRR

|

WRR

|

|

|

Ruijie(config)# **no priority-queue**

show mls qos queueing	-

|

-	-

44.2.12 priority-queue cos-map

CoS

priority-queue cos-map *qid cos0 [cos1 [cos2 [cos3 [cos4 [cos5 [cos6 [cos7]]]]]]]*

no priority-queue cos-map

<i>qid</i>	id
<i>cos7</i>	<i>cos0 ...</i> CoS
<i>no</i>	

|

|

|

```
Ruijie(config)# priority-queue cos-map 1 0 1
```

show mls qos queueing	-

-	-

44.2.13 service-policy

policy map

service-policy {input | output} *policy-map-name*

no service-policy {input | output}

<i>policy-map-name</i>	polycymap
no	policy map

```
Ruijie(config)# interface fastEthernet 0/1
```

```
Ruijie(config-if)# service-policy input po
```

show mls qos interface	-

-	-

44.2.14 wrr-queue bandwidth

WRR

wrr-queue bandwidth *weight1 ... weightn*

no wrr-queue bandwidth

<i>weight1...weightn</i>	n	n
no		

weight1: ...: weightn = 1:::1

Ruijie(config)# **wrr-queue bandwidth 1 2 3 4 5 6 7 8**

show mls qos queueing	-

-	-

44.3

44.3.1 show class-map

class map

show class-map [*class-name*]

<i>class-name</i>	class map

class map

Ruijie# **show class-map**

-	-
-	-

44.3.2 show policy-map

QoS policy map [class class-name]

show policy-map [*policy-name* **class** *class-name*]

<i>policy-name</i>	policy name
<i>class-name</i>	class map

policy name

Ruijie# **show policy-map**

-	-

ip-prec-dscp	ip-prec-dscp maps
---------------------	-------------------

dscp-cos maps dscp-cos maps ip-prec-dscp maps

┌

┌

Ruijie# **show mls qos maps**

-	-

┌

-	-

44.3.5 show mls qos queueing

QoS (cos-to-queue map,wrr weight,drr weight)

show mls qos queueing

-	-

┌

┌

┌

Ruijie# **show mls qos queueing**

-	-

	-	-

44.3.6 show mls qos rate-limit

show mls qos rate-limit [*interface interface-id*]

interface	interface-id	rate-limit

|

|

|

Ruijie# **show mls qos rate-limit**

--	--	--

|

|

|

Ruijie# **show mls qos scheduler**

|

-	-

|

-	-

show voice vlan

Voice VLAN
45-2

45.1.3 voice vlan cos

Voice VLAN CoS **no**

voice vlan cos *cos-value*

no voice vlan cos

<i>cos-value</i>	Voice VLAN	CoS
------------------	------------	-----

cos-value 6

Voice VLAN CoS DSCP

1 Voice VLAN CoS 5

Ruijie(config)# **voice vlan cos 5**

	Voice VLAN	CoS
--	------------	-----

show voice vlan

Voice VLAN

cah8bHT"tj5P#\$16APPBDry@ gpm&

<i>dscp-value</i>	Voice VLAN	DSCP
-------------------	------------	------

<i>dscp-value</i>	46	
-------------------	----	--

Voice VLAN	CoS	DSCP
------------	-----	------

1	Voice VLAN	DSCP	40
---	------------	------	----

```
Ruijie(config)# voice vlan dscp 40
```

--	--

show voice vlan

Voice VLAN

```
1      OUI      0012.3400.0000  Voice VLAN      Company A
Ruijie(config)# voice vlan mac-address 0012.3400.0000 mask
                ffff.ff00.0000 description Company A
```

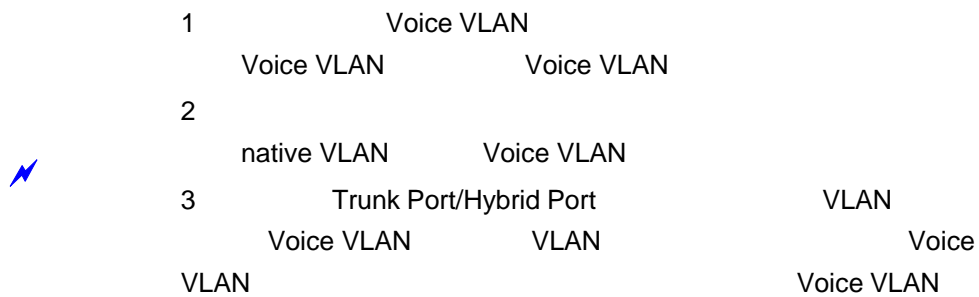

Voice VLAN OUI	MAC	MAC
	Voice VLAN	
	Voice VLAN	
	untagged	Voice VLAN tag
	MAC VLAN	Voice VLAN tag Voice VLAN /

1 Voice VLAN
Ruijie(config)# voice vlan security enable

show voice vlan	Voice VLAN



|

Voice VLAN

Voice VLAN

```

1          Voice VLAN
Ruijie(config)# show voice vlan
Voice VLAN status: ENABLE           //Voice VLAN
Voice VLAN ID: 2                     //Voice VLAN ID
Voice VLAN security mode: Security //
Voice VLAN aging time: 5 minutes    //
Voice VLAN cos: 6                    //      CoS
Voice VLAN dscp: 46                  //      DSCP
Current voice vlan enabled port mode: //      Voice VLAN
PORT                                MODE
-----
Fa0/1                                Auto
    
```

	Voice VLAN	Voice VLAN
voice vlan <i>vlan-id</i>	Voice VLAN VLAN	Voice VLAN
voice vlan aging <i>minutes</i>	Voice VLAN	
voice vlan cos <i>cos-value</i>	Voice VLAN	CoS
voice vlan dscp <i>dscp-value</i>	Voice VLAN	DSCP
voice vlan enable	Voice VLAN	
voice vlan mode auto	Voice VLAN	
voice vlan security enable	Voice VLAN	

10.4	
------	--

45.2.2 show voice vlan oui

OUI OUI

show voice vlan oui

Voice VLAN

--	--	--

┌

┌

47 RLDP

47.1

47.1.1 rldp detect-interval

RLDP

rldp detect-interval *interval*

no rldp detect-interval

<i>interval</i>		2-15

3

stp × stp

5s :
Ruijie(config)# **rldp detect-interval** 5

rldp detect-max		

-		-

47.1.2 rldp detect-max

RLDP

rldp detect-max *num*

no rldp detect-max

	<i>num</i>	, 2-10

2

5

Ruijie(config)# **rldp detect-max 5**

	rldp detect-interval	

	-	-

47.1.3 rldp enable

RLDP

rldp enable

no rldp enable

--	--	--

	RLDP	RLDP
	Ruijie(config)# rldp enable	
	rldp port	RLDP
	-	-

47.1.4 rldp port

rldp

rldp port { unidirection-detect | bidirection-detect | loop-detect } { warning | shutdown-svi | shutdown-port | block }

no rldp port { unidirection-detect | bidirection-detect | loop-detect }

	unidirection-detect	
	bidirection-detect	
	loop-detect	
	warning	
	shutdown-svi	shutdown svi
	shutdown-port	shutdown
	block	

	RLDP	RLDP
	fas 0/1	rldp

```
Ruijie(config)# interface fas 0/1
Ruijie(config-if)# rldp port loop-detect block
```

rldp enable	rldp

-	-

47.1.5 rldp reset

rldp shutdown disable rldp

rldp reset

-	-

```
Ruijie# rldp reset
```

rldp enable	Rldp

-	-

47.2

47.2.1 show rldp

rldp

show rldp [interface *interface-id*]

	<i>Interface-id</i>	
	EXEC	
	-	-
	-	-

47.2.2 debug rldp

rldp

no

debug rldp [packet | event | error]

undebug rldp [packet | event | error]

	packet	rldp
	event	
	error	

└──

└── EXEC

└──

└──

└──

-	-

└──

└──

-	-

48 TPP

48.1

48.1.1 topology guard

topology guard

no

[no] topology guard

-	-

┌

┌

┌

cpu topology-limit

```
Ruijie(config)# topology guard
Ruijie(config)# no topology guard
```

┌

tp-guard port enable	
cpu topology-limit	CPU

┌

-	-

48.1.2 tp-guard port enable

no

[no] tp-guard port enable



|

|

tpp

|

Ruijie# **show tpp**

|

topology guard	

|

|

-	-

49

49.1

49.1.1 cd

`cd [filesystem.:][directory]`

49.1.2 copy

copy *source-url destination-url*

<i>source-url</i>	URL
<i>destination-url</i>	URL

```

Ruijie#copy tftp://192.168.201.54/rgos.bin flash:/
  2          tftp
Ruijie#copy flash:/rgos.bin tftp://192.168.201.54/rgos.bin
  3          xmodem
Ruijie# copy xmodem: flash:/config.text
  4          U
Ruijie#copy flash:/config.text usb0:/config.text
  5
Ruijie#copy flash:/config.text slave:/config.text
  6          flash      sd
Ruijie#copy flash:/rgos.bin sd0:/rgos.bin
  7          U          sd
Ruijie#copy usb0:/config.text sd0:/config.text
  8          sd          U
Ruijie#copy sd0:/config.text usb0:/config.text

```

del	
rename	
dir	

49.1.3 delete

delete url

<i>url</i>	<i>url</i>



url



1

Ruijie# **dir** slave0:/

Directory of slave:/

Mode	Link	Size	MTime	Name
1		10838016	2008-01-01 00:01:53	rgos.bin
1		399	2008-01-01 00:01:37	config.text
1		399	2008-01-01 00:17:58	cfg.txt

3 Files (Total size 11210782 Bytes), 0 Directories.

Total 33030144 bytes (31MB) in this device, 20463616 bytes (19MB) available.

2

Ruijie# **dir**

Directory of temp:/

Mode	Link	Size	MTime	Name
1		399	2008-01-01 00:17:58	a.dat

1 Files (Total size 399 Bytes), 0 Directories.

Total 33030144 bytes (31MB) in this device, 20463616 bytes (19MB) available.

pwd	
cd	

49.1.5 mkdir

mkdir *directory*

<i>directory</i>	

└──

└──

()

⚡ flash:/backup/temp flash:/backup
flash:/bakcup

flash:/backup/temp

1 test
Ruijie# **mkdir** test

2 sd test2
Ruijie# **mkdir** sd0:/test2

rmdir	
pwd	

└──

--	--

49.1.6 rename

rename *url1 url2*

<i>url1</i>		URL
<i>url2</i>		URL

usb0/1, flash, slave

49.1.7 rmdir

rmdir *directory*

<i>directory</i>	,

--

--

--

--

tmp
Ruijie# **rmdir** tmp

mkdir	

--

49.2

49.2.1 pwd

pwd

└──

└──

└──

└──
1
Ruijie# **pwd**
flash:/

cd	

└──

49.2.2 show file systems

show file systems

└──

|

|

|

1
Ruijie#show file systems

|

|

|

50

50.1 CPU

50.1.1 cpu-log

CPU , **cpu-log**
cpu-log *log-limit low_num high_num*

	-	-
	-	-

50.1.2 show cpu

	CPU	show cpu
show cpu		
	-	-

		CPU	5	1	5
	CPU		5	1	5
	CPU				

```

show cpu
Ruijie# show cpu
=====
      CPU Using Rate Information
CPU utilization in five seconds: 25%
CPU utilization in one minute  : 20%
CPU utilization in five minutes: 10%
NO   5Sec  1Min  5Min  Process
0    0%   0%   0%   LISR INT
1    7%   2%   1%   HISR INT
2    0%   0%   0%   ktimer
3    0%   0%   0%   atimer
4    0%   0%   0%   printk_task

```

5	0%	0%	0%	waitqueue_process
6	0%	0%	0%	tasklet_task
7	0%	0%	0%	kevents
8	0%	0%	0%	snmpd
9	0%	0%	0%	snmp_trapd
10	0%	0%	0%	mtdblock
11	0%	0%	0%	gc_task
12	0%	0%	0%	Context
13	0%	0%	0%	kswapd
14	0%	0%	0%	bdflush
15	0%	0%	0%	kupdate
16	0%	3%	1%	ll_mt
17	0%	0%	0%	ll main process
18	0%	0%	0%	bridge_relay
19	0%	0%	0%	dlx_task
20	0%	0%	0%	secu_policy_task
21	0%	0%	0%	dhcpa_task
22	0%	0%	0%	dhcpsnp_task
23	0%	0%	0%	igmp_snp
24	0%	0%	0%	mstp_event
25	0%	0%	0%	GVRP_EVENT
26	0%	0%	0%	rldp_task
27	0%	2%	1%	rerp_task
28	0%	0%	0%	reup_event_handler
29	0%	0%	0%	tpp_task
30	0%	0%	0%	ip6timer
31	0%	0%	0%	rtadvd
32	0%	0%	0%	tnet6
33	2%	0%	0%	tnet
34	0%	0%	0%	Tarptime
35	0%	0%	0%	gra_arp
36	0%	0%	0%	Ttcptimer
37	8%	1%	0%	ef_res
38	0%	0%	0%	ef_rcv_msg
39	0%	0%	0%	ef_inconsistent_daemon
40	0%	0%	0%	ip6_tunnel_rcv_pkt
41	0%	0%	0%	res6t
42	0%	0%	0%	tunrt6
43	0%	0%	0%	ef6_rcv_msg

44	0%	0%	0%	ef6_inconsistent_daemon
45	0%	0%	0%	imid
46	0%	0%	0%	nsmd
47	0%	0%	0%	ripd
48	0%	0%	0%	ripngd
49	0%	0%	0%	ospfd
50	0%	0%	0%	ospf6d
51	0%	0%	0%	bgpd
52	0%	0%	0%	pimd
53	0%	0%	0%	pim6d
54	0%	0%	0%	pdmd
55	0%	0%	0%	dvmrpd
56	0%	0%	0%	vty_connect
57	0%	0%	0%	aaa_task
58	0%	0%	0%	Tlogtrap
59	0%	0%	0%	dhcp6c
60	0%	0%	0%	sntp_recv_task
61	0%	0%	0%	ntp_task
62	0%	0%	0%	sla_daemon
63	0%	3%	1%	track_daemon
64	0%	0%	0%	pbr_guard
65	0%	0%	0%	vrrpd
66	0%	0%	0%	psnpd
67	0%	0%	0%	igsnpd
68	0%	0%	0%	coa_recv
69	0%	0%	0%	co_oper
70	0%	0%	0%	co_mac
71	0%	0%	0%	radius_task
72	0%	0%	0%	tac+_acct_task
73	0%	0%	0%	tac+_task
74	0%	0%	0%	dhcpd_task
75	0%	0%	0%	dhcps_task
76	0%	0%	0%	dhcpping_task
77	0%	0%	0%	dhcpc_task
78	0%	0%	0%	uart_debug_file_task
79	0%	0%	0%	ssp_init_task
80	0%	0%	0%	rl_listen
81	0%	0%	0%	ikl_msg_operate_thread
82	0%	0%	0%	bcmDPC

83	0%	0%	0%	bcmL2X.0	
84	3%	3%	3%	bcmL2X.0	
85	0%	0%	0%	bcmCNTR.0	
86	0%	0%	0%	bcmTX	
87	0%	0%	0%	bcmXGS3AsyncTX	
88	0%	2%	1%	bcmLINK.0	
89	0%	0%	0%	bcmRX	
90	0%	0%	0%	mngpkt_rcv_thread	
91	0%	0%	0%	mngpkt_recycle_thread	
92	0%	0%	0%	stack_task	
93	0%	0%	0%	stack_disc_task	
94	0%	0%	0%	redun_sync_task	
95	0%	0%	0%	conf_dispatch_task	
96	0%	0%	0%	devprob_task	
97	0%	0%	0%	rdp_snd_thread	
98	0%	0%	0%	rdp_rcv_thread	
99	0%	0%	0%	rdp_slot_change_thread	
100	4%	2%	1%	datapkt_rcv_thread	
101	0%	0%	0%	keepalive_link_notify	
102	0%	0%	0%	rerp_msg_rcv_thread	
103	0%	0%	0%	ip_scan_guard_task	
104	0%	0%	0%	ssp_ipmc_hit_task	
105	0%	0%	0%	ssp_ipmc_trap_task	
106	0%	0%	0%	hw_err_snd_task	
107	0%	0%	0%	rerp_packet_send_task	
108	0%	0%	0%	idle_vlan_proc_thread	
109	0%	0%	0%	cmic_pause_detect	
110	1%	1%	1%	stat_get_and_send	
111	0%	1%	0%	rl_con	
112	75%	80%	90%	idle	
		3	5	1	5
	CPU	LISR	HISR		CPU

No	
5Sec	5 CPU
1Min	1 CPU
5Min	5 CPU

2

,X

bgp

/

1 BGP
Ruijie(config)# **memory-lack exit-policy bgp**

show memory	

-

10.3(4b3)	

50.2.2 show memory

show memory

show memory

-	-

└───┘

└───┘

└───┘

└───┘

show memory

Ruijie#show memory

System Memory Statistic:

Free pages: 1079

watermarks : min 379, lower 758, low 1137, high 1516

System Total Memory : 128MB, Current Free Memory : 5283KB

Used Rate : 96%

1. 4k

2.

min	
lower	memory-lack exit-policy
low	OVERFLOW
high	OVERFLOW

3.

-	-

-	-

50.2.3 show memory protocols

show memory protocols

51

51.1

51.1.1 clear logging

clear logging

	-	-

Ruijie# clear logging

	logging on	
	show logging	
	logging buffered	

	-	-

51.1.2 more flash

FLASH

more flash:filename

<i>Filename</i>	

└──

└──

└──

FLASH "/f2/" "/f3/

└──

```
FLASH
Ruijie# more flash://f2/log.txt
look up file in the extended flash://f2/log.txt
00004 2004-11-17 4:1:32 Ruijie: %5:Reload requested by
Administrator. Reload Reason :Reload command
```

└──

logging file flash:	FLASH

└──

└──

-	-

51.1.3 logging buffered

nonle f

<i>levell</i>	0 7
---------------	-----

4k Bytes
7

show logging

clear logging
FLASH

Syslog Server

8

Emergencies	0	
Alerts	1	
Critical	2	
Errors	3	
warnings	4	
Notifications	5	
informational	6	
Debugging	7	

0

6

6

10000

Ruijie(config)# **logging buffered 10000 6**

logging on	
show logging	
clear logging	

	-	-

51.1.4 logging console

no

logging console level

no logging console

		0 7
<i>level</i>		1

Debugging (7)

show logging

6
Ruijie(config)# **logging console informational**

	logging on	
	show logging	

	-	-

51.1.5 logging count

no

logging count

no logging count

	-	-

|

|

|

no logging count

|

Ruijie(config)# **logging count**

show logging count		
show logging		

|

	-	-

51.1.6 logging facility

no

(23)

logging facility *facility-type*

no logging facility

<i>facility-type</i>	Syslog
----------------------	--------

Local7(23)

2 Syslog

Numerical Code	Facility
0	kernel messages
1	user-level messages
2	mail system
3	system daemons
4	security/authorization messages
5	messages generated internally by syslogd
6	line printer subsystem
7	network news subsystem
8	UUCP subsystem
9	clock daemon
10	security/authorization messages
11	FTP daemon
12	NTP subsystem
13	log audit
14	log alert
15	clock daemon
16	local use 0 (local0)
17	local use 1 (local1)
18	local use 2 (local2)
19	local use 3 (local3)
20	local use 4 (local4)
21	local use 5 (local5)
22	local use 6 (local6)
23	local use 7 (local7)

(local7) 23

Syslog kernel

Ruijie(config)# **logging facility kern**

logging console



FLASH
FLASH logging file flash

FLASH

FLASH

trace.txt

64K,

6

Ruijie(config)# logging file flash:trace

logging on	
show logging	
more flash	FLASH

-	-

51.1.8 logging monitor

VTY

telnet

SSH

no

VTY

logging monitor *level*

no logging monitor

--	--

level

50648 ref66.82 -32.68 62.76 0.24 ref142.32534.98 154.38 1.5 r

VTY

6

Ruijie(config)# **logging monitor informational**

logging on	
show logging	

--	--

logging	Syslog Server
logging file flash:	FLASH
logging console	
logging monitor	VTY (telnet)
logging trap	Syslog Server

-	-

51.1.10 logging rate-limit

no

logging rate-limit {*number* | *all number* | *console {number | all number}*} [*except severity*]

no logging rate-limit

<i>number</i>	1—10000
<i>all</i>	0—7
<i>console</i>	
<i>except</i>	error(3) error
<i>severity</i>	0—7

debug 10 warning

Ruijie(config)#**logging rate-limit all 10 except warnings**

show logging count

```

2                IPV6      AAAA:BBBB::FFFF
Ruijie(config)# logging server ipv6 AAAA:BBBB::FFFF

```

logging on	
show logging	
logging trap	syslog server

-	-

51.1.12 logging source ip| ipv6

no

logging source {ip *ip-address* | ipv6 *ipv6-address*}

no logging source {ip | ipv6}

<i>ip-address</i>	IPV4	IPV4
<i>ipv6-address</i>	IPV6	IPV6

Syslog Server

	-	-
--	---	---

51.1.14 logging synchronous

no

logging synchronous

no logging synchronous

	-	-

┌
└
┌
└
┌

```
Ruijie(config)#line console 0
Ruijie(config-line)#logging synchronous
                        UP-DOWN
Ruijie#configure terminal
Oct  9 23:40:55 %LINK-5-CHANGED: Interface GigabitEthernet 0/1,
changed state to down
Oct  9 23:40:55 %LINEPROTO-5-UPDOWN: Line protocol on Interface
GigabitEthernet 0/1, changed state to DOWN
Ruijie# configure terminal      //
```

	show running-config	

┌

	-	-

51.1.15 logging trap

Syslog Server

service sequence-numbers

no service sequence-numbers

	-	-

```

Mar 22 15:28:02 %SYS-5-CONFIG: Configured from console by console
Ruijie# config terminal
Enter configuration commands, one per line. End with CNTL/Z.
Ruijie(config)# service sysname
Ruijie(config)# end
Mar 22 15:35:57 S3250 %SYS-5-CONFIG: Configured from console by
console

```

show logging	

-	-

51.1.18 service timestamps

no

default

service timestamps *message-type* [*uptime* | *datetime* [*msec* | *year*]]

no service timestamps *message-type*

default service timestamps *message-type*

<i>message-type</i>	log debug log 0 6 debug 7
<i>uptime</i>	

msec

. Jul 27 16:53:07.299

: :

	-	-

show logging

```
Ruijie# show logging
Syslog logging: enabled
Console logging: level debugging, 4 messages logged
Monitor logging: level informational, 0 messages logged
Buffer logging: level debugging, 6 messages logged
Timestamp debug messages: datetime
Timestamp log messages: disabled
Sequence log messages: enable
Trap logging: level debugging, 2 message lines logged,0 reserved,0
fail
logging to 202.101.11.22
logging to 192.168.200.112
Log Buffer (Total 4096 Bytes) : have written 680
00001 2004-11-17 10:20:59 Ruijie: %7:%LINK CHANGED: Interface
FastEthernet 0/0, changed state to up
00002 2004-11-17 10:20:59 Ruijie: %7:%LINE PROTOCOL CHANGE:
Interface FastEthernet 0/0, changed state to UP
00003 2004-11-17 10:57:18 Ruijie: %7:%LINK CHANGED: Interface
FastEthernet 0/1, changed state to administratively down
00004 2004-11-17 10:57:21 Ruijie: %7:%LINK CHANGED: Interface
FastEthernet 0/1, changed state to down
00005 2004-11-17 10:57:41 Ruijie: %7:%LINK CHANGED: Interface
FastEthernet 0/1, changed state to administratively down
00006 2004-11-17 10:57:43 Ruijie: %7:%LINK CHANGED: Interface
FastEthernet 0/1, changed state to down
```

Syslog logging	enabled, disabled
Console logging	
Monitor logging	VTY
Buffer logging	
Timestamp debug messages	Debug
Timestamp log messages	Log
Sequence log messages	

Trap logging	Syslog Server
Log Buffer	
logging on	
clear logging	
-	-

51.2.2 show logging count

show logging count

-	-
---	---

```

logging count
show logging

```

```

show logging count
Ruijie# show logging count
Module Name  Message Name Sev Occur      Last Time
=====SYS
CONFIG_I     5  1      Jul 6 10:29:57
-----SYS      TOTAL      1

```

--	--

	logging count	
	show logging	
	clear logging	
	-	-

52 POE

52.1

52.1.1 Poe disconnect-mode mode/no poe disconnect-mode

mode	[ac/dc]

┌

┌

┌

```

POE
dc
Ruijie# configure
Ruijie(config)# poe disconnect-mode dc
Ruijie(config)# end
    
```

-	-

┌

-	-

52.1.2 Poe enable/no poe enable

--	-

┌

┌

┌

```
Ruijie(config-if)#
Ruijie(config-if)# poe enable
Ruijie(config-if)# no poe enable
Ruijie(config-if)#
```

-	-

┌

┌

-	-

52.1.3 Poe-power lower lower/no poe-power lower

┌

<i>lower</i>	[45000-47000]

┌

┌

┌

```
POE 46000
Ruijie# configure
Ruijie(config)# poe-power lower 46000
Ruijie(config)# end
```

--	--

POE

	-	-
	-	-

52.1.4 Poe-power upper lower/no poe-power upper

	<i>upper</i>	[55000-57000]

┌

└

┌

└

```
POE 56000
Ruijie# configure
Ruijie(config)# poe-power upper 56000
Ruijie(config)# end
```

	-	-

┌

└

	-	-

52.2

52.2.1 show poe interfaces

-	-

└───┘

└───┘

└───┘

poe

```
Ruijie# show poe interface gigabitethernet 0/2
Interface : Gi0/2
Port power enabled : ENABLE
Port connect status : OFF
Port PD Class : no PD devices
Port max power : 15400 mW
Port current power : 0 mW
Port peak power : 0 mW
Port current : 0 mA
Port voltage : 48082 mV
Port trouble cause : normal
```

-	-

└───┘

-	-

52.2.2 show poe powersupply

-	-

└───┘

POE

```
Ruijie# show poe powersupply
PSE Total Power : 379971 mW
PSE Total Power Consumption : 0 mW
PSE Available Power : 379971 mW
PSE Peak Value : 0 mW
PSE Min Allow Voltage : 45000 mV
PSE Max Allow Voltage : 57000 mV
PSE Disconnect Sense Mode : ac
```

53

53.1

53.1.1 device-priority

device-priority [*member*] *priority*

<i>member</i>	ID member 1
<i>priority</i>	[1, 10]

|

|

```
1 10 10
1
write
```

```
2 8
Ruijie(config)# device-priority 2 8
```

show member	

|

-	-

53.1.2 device-description

device-description [

member <i>member</i>	ID member 1
<i>description</i>	31

└───┘

└───┘

└───┘

└───┘

```

write
2 red-giant
Ruijie(config)# device-description member 2 red-giant

```

show member	

└───┘

-	-

53.2

53.2.1 show member

show member [*member*]

<i>member</i>	ID

└───┘

└───┘

└───┘

Ruijie# **show member**

```
Member Mac Address      Priority Software Version
HardwareVersion Description
-----
1 00d0.f810.3323 1 RGOS 10.1.00(2),Release(12889) 1.0 SWITCH
2 00d0.f822.33aa 1 RGOS 10.1.00(2),Release(12889) 1.0 SWITCH
3 00d0.f822.33ae 1 RGOS 10.1.00(2),Release(12889) 1.0 SWITCH
4 00d0.f822.33b0 1 RGOS 10.1.00(2),Release(12889) 1.0 SWITCH
5 00d0.f822.33b2 1 RGOS 10.1.00(2),Release(12889) 1.0 SWITCH
6 00d0.f824.23b4 1 RGOS 10.1.00(2),Release(12889) 1.0 SWITCH
7 00d0.f833.44b4 1 RGOS 10.1.00(2),Release(12889) 1.0 SWITCH
8 00d0.f855.33ae 1 RGOS 10.1.00(2),Release(12889) 1.0 SWITCH
```

-	-

-	-