

RG-IS2700G



Contents

SmartWeb

ERPS

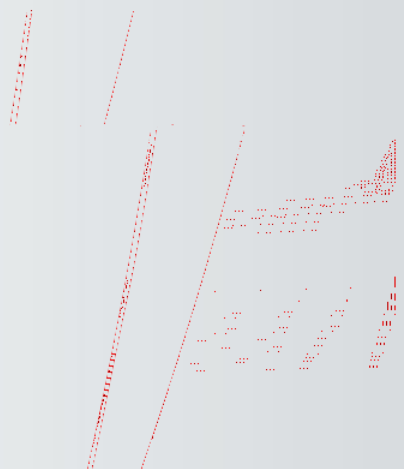
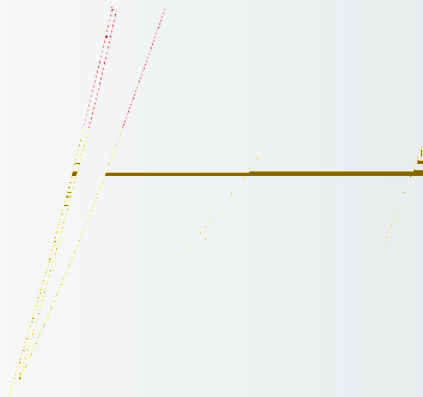



(ERPS)

ERPS(Ethernet Ring Protection Switching)

ITU

G.8032

ERPS EAPS RPR SDH STP

ERPS

STP

STP

ERPS

50ms

(ERPS)

ERPS ring 1

ERPS ring2

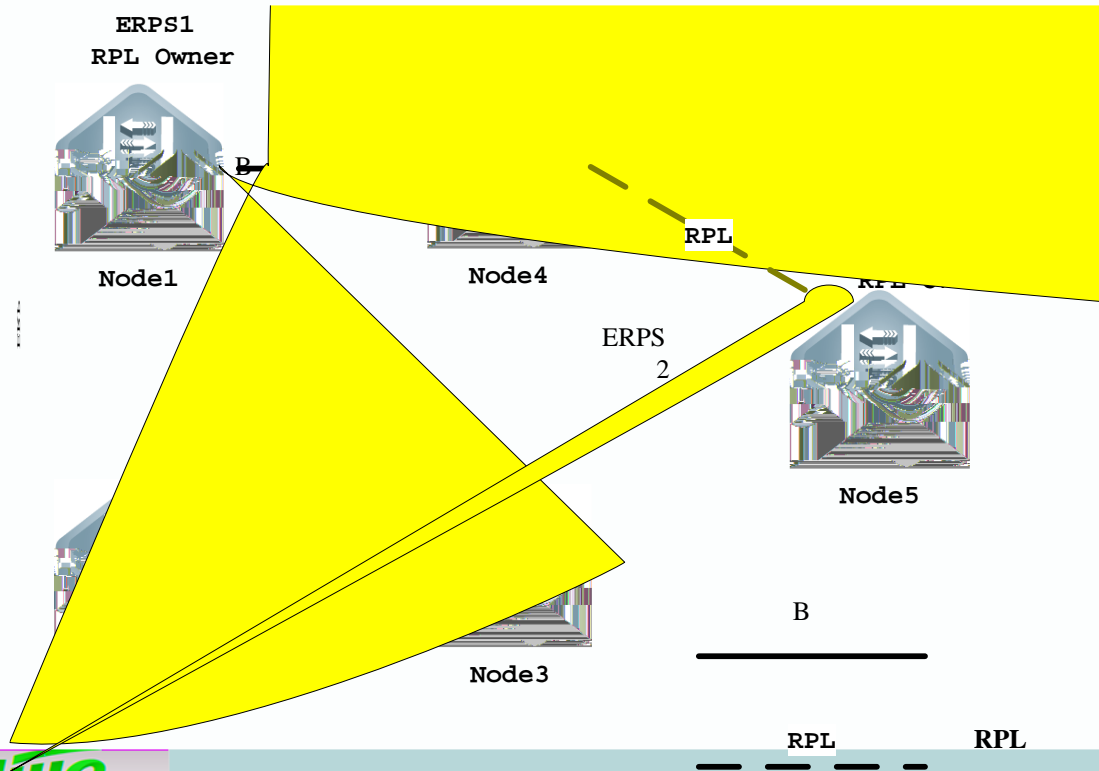

(ERPS)

2

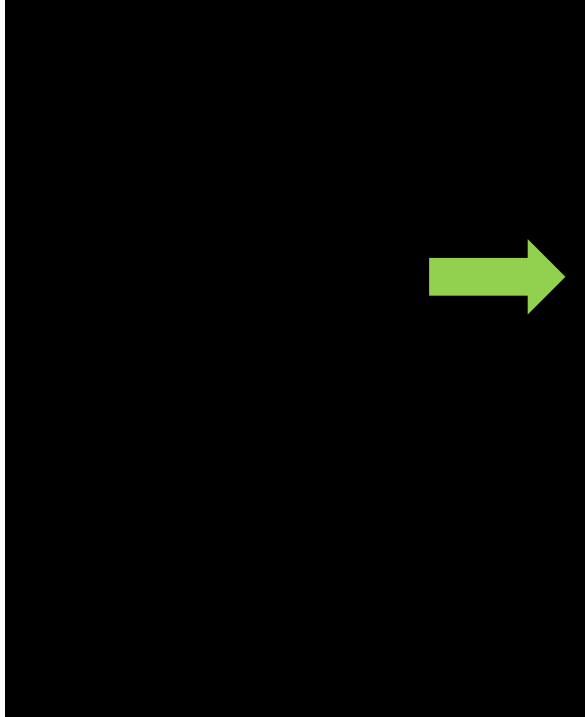

ERPS
TCP

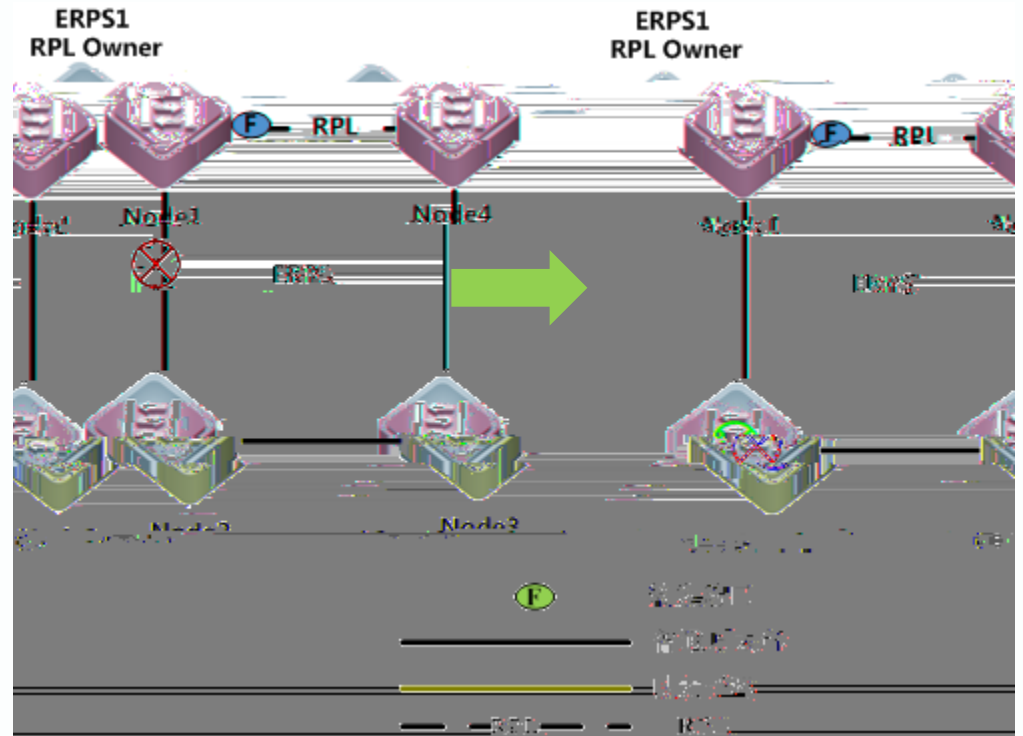

RPL Owner

(ERPS)

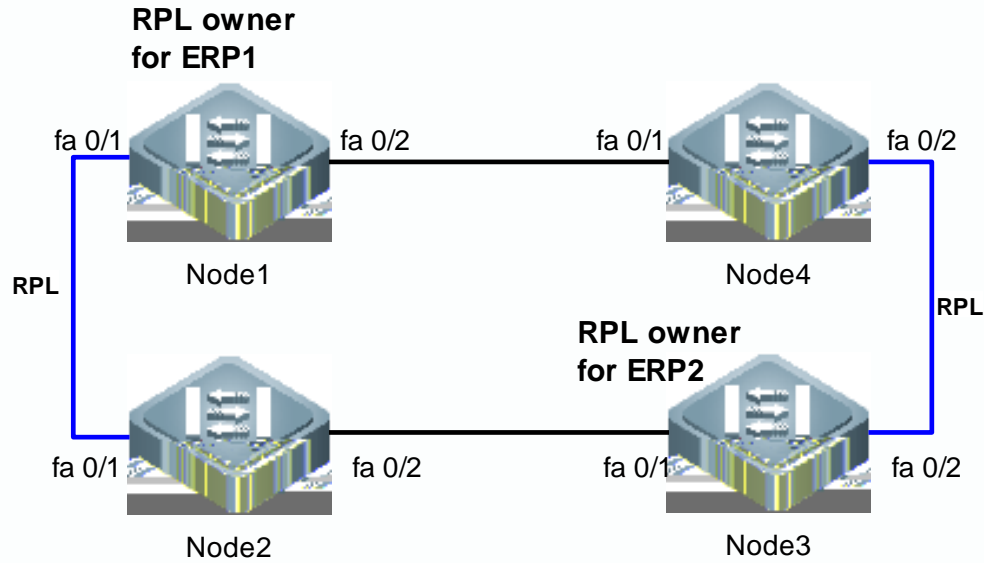

VLAN

VLAN

VLAN



(ERPS)



(ERPS)

ERPS

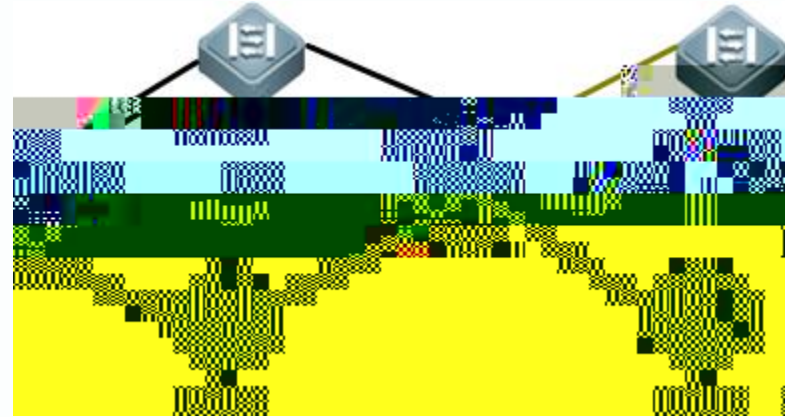
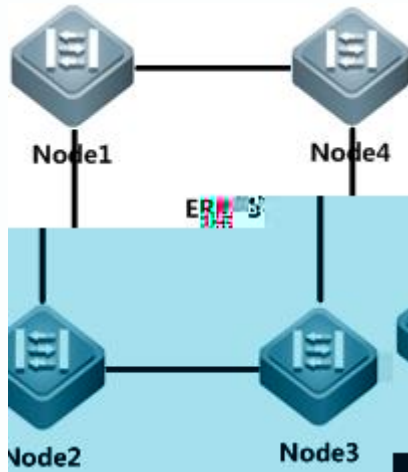

1

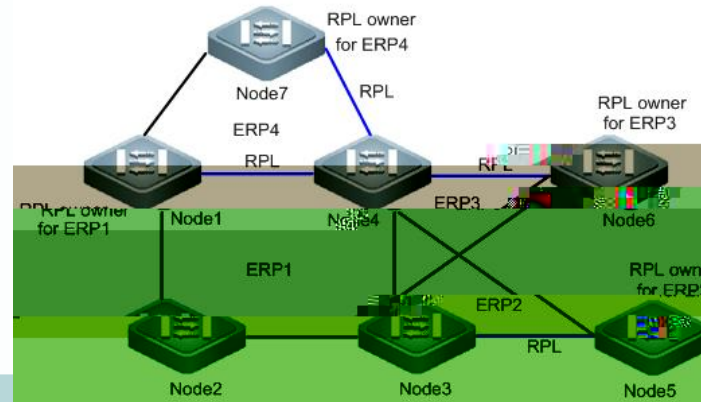
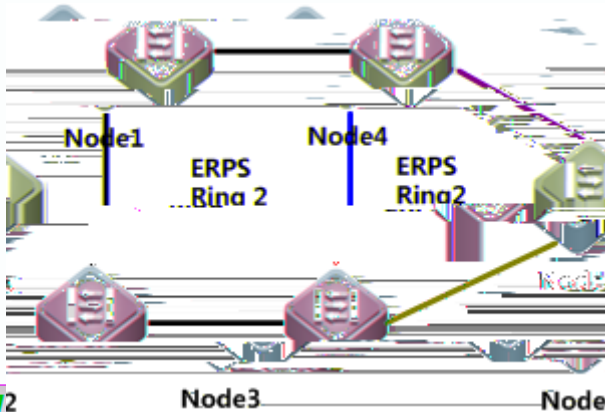

(ERPS)

ERPS

RPL() RPL Idle RPL

ERP2 Node4 Node5 Node3 Node5 ERP1
ERP1 Node3 Node4 ERP1

ERP2 ERP2

R-APS virtual channel

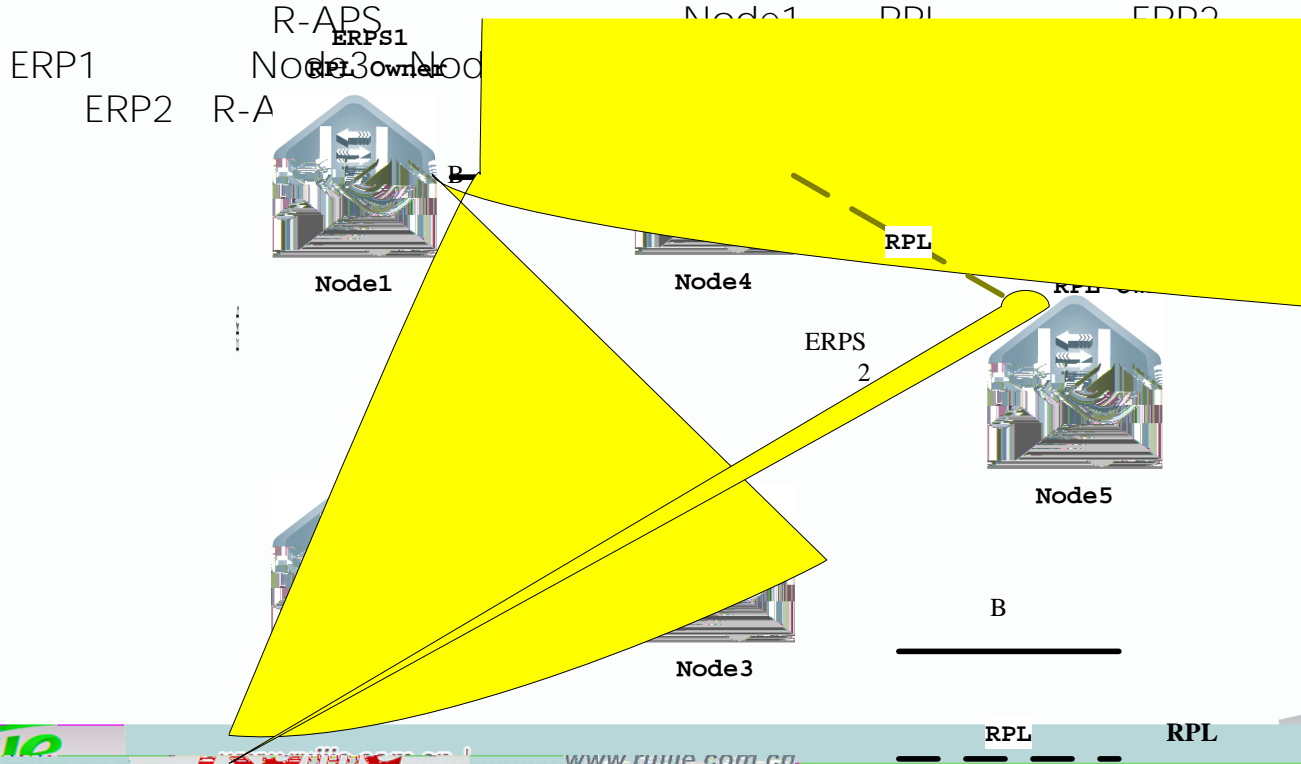

(ERPS)

ERPS

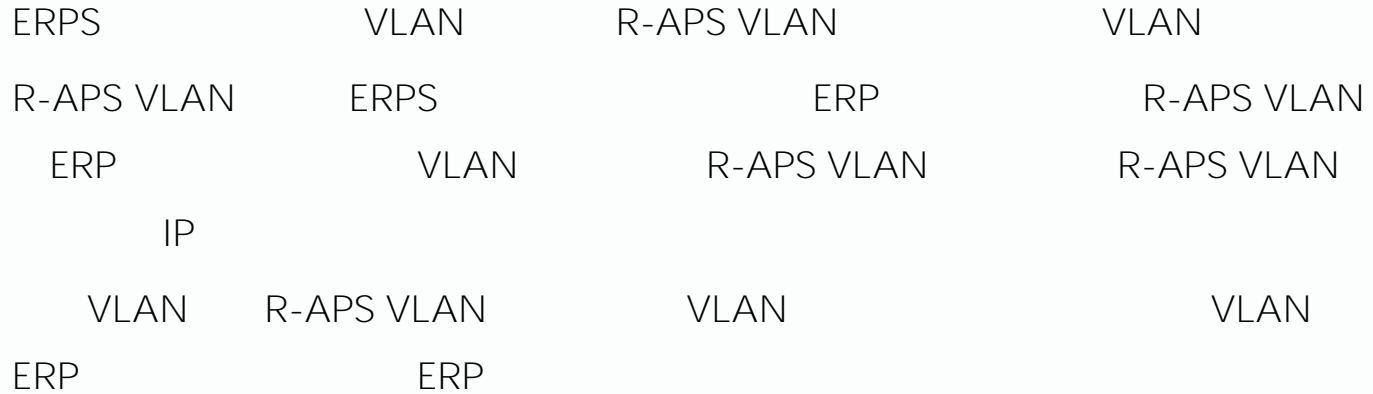

Idle

Protection

(ERPS)

ERPS

Switch1 Switch2 Switch3

R-APS VLAN ID

RPL owner

Switch3 RPL Owner

Switch2 Switch3

RPL

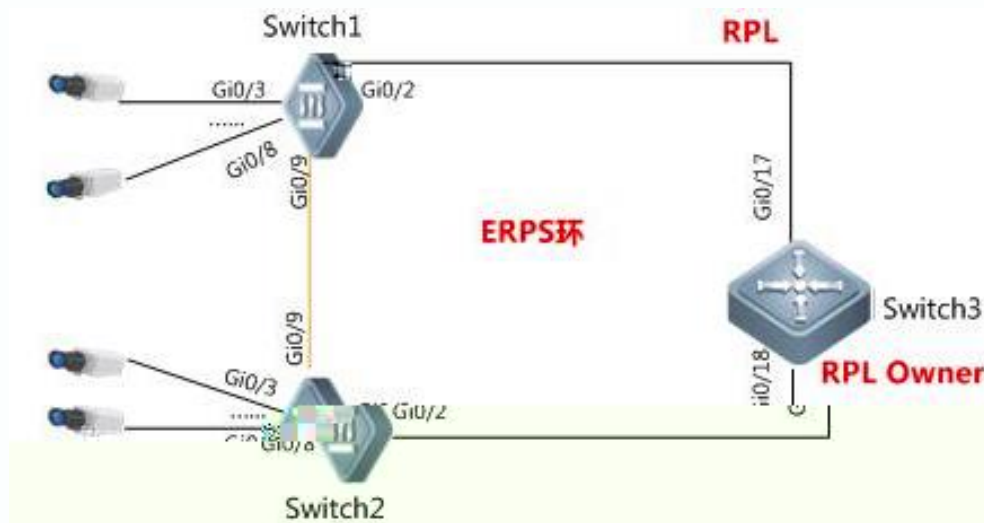

(ERPS)

ERPS

IS2700_1 IS2700_2 Switch3

ERPS IS2700_3 IS2700_4

Switch3

ERPS

ERPS

ERPS

R-APS VLAN

R-Aps vlan id

RPL Owner

Switch3

RPL owner

Switch3

IS2700_1

ERPS

RPL

Switch3

IS2700_3

ERPS

RPL

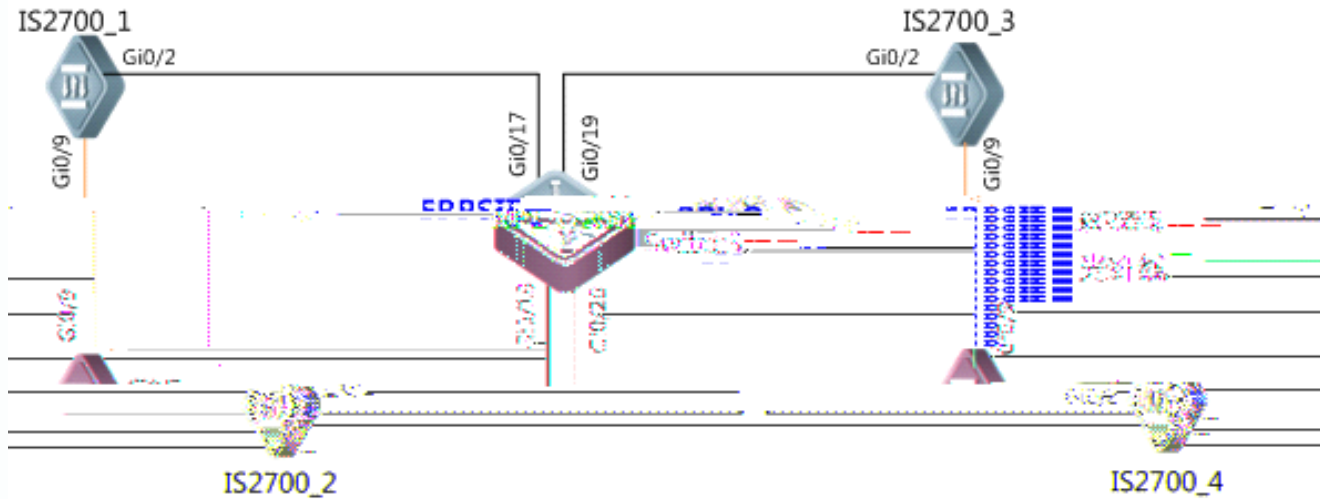

(ERPS)

ERPS

Node1 Node2 Node3 Node4

ERPS 1 Node3 Node4

Node5 ERP2

R-APS VLAN ERP1 R-APS VLAN 4093 ERP2 R-APS VLAN 100

RPL Owner Node1 RPL owner Node1 Node4 ERP1

RPL Node5 RPL owner Node4 Node5 ERP2 RPL

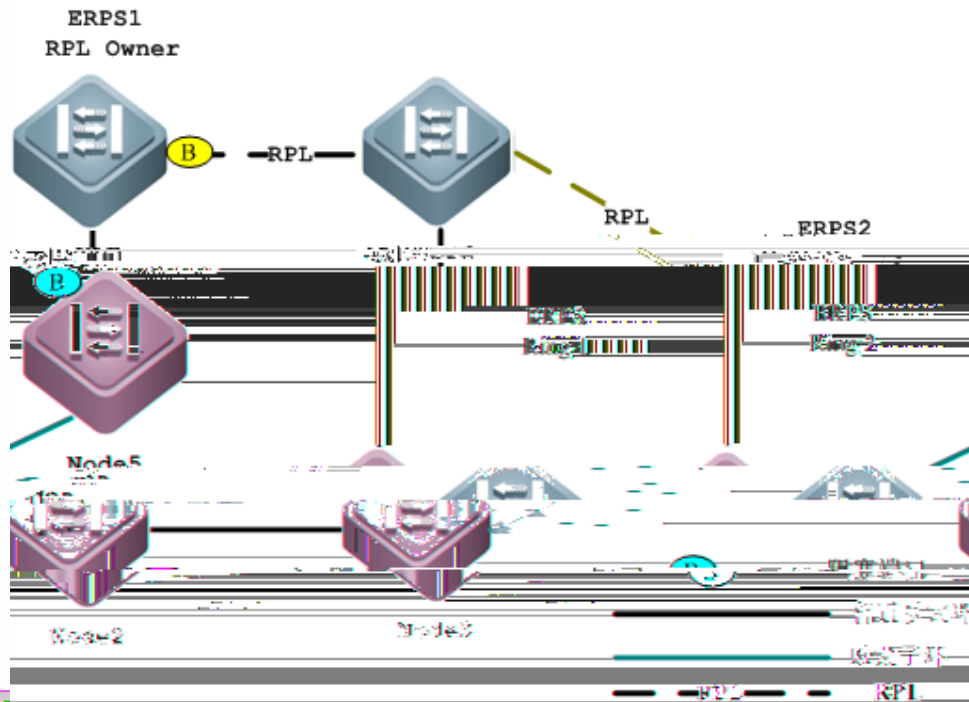



(ERPS)

ERPS

Switch1



(ERPS)

ERPS

CLI

R-APS VLAN

RLDP

(ERPS)



```
RPL Owner    Switch3
Ruijie# configure terminal
Ruijie(config)# erps raps-vlan 4001
Ruijie(config)#int gigabitEthernet 0/17
Ruijie(config-if-GigabitEthernet 0/17)# switchport mode trunk
Ruijie(config-if-GigabitEthernet 0/17)#rldp port bidirection-detect shutdown-port
Ruijie(config)#int gigabitEthernet 0/18
Ruijie(config-if-GigabitEthernet 0/18)# switchport mode trunk
Ruijie(config-if-GigabitEthernet 0/18)#rldp port bidirection-detect shutdown-port
Ruijie# configure terminal
Ruijie(config)#rldp enable
Ruijie(config)#errdisable recovery interval 30
Ruijie(config)# erps raps-vlan 4001
Ruijie(config-erps 4001)#ring-port west gigabitEthernet 0/17 east gigabitEthernet 0/18
Ruijie(config-erps 4001)#rpl-port east rpl-owner
Ruijie(config)# erps raps-vlan 4001
Ruijie(config-erps 4001)# state enable
Ruijie(config)# erps enable
```

R-APS VLAN VLAN ID 4001

RLDP

RPL-Owner

ERPS ERPS

(ERPS)

ERPS

WEB



RPL Owner WEB

以太环配置

Erps ID(2-4094): 4001 *

请选择Erps环端口：（只能选择两个端口）

2 4 6

1 3 5

可选端口 不可选端口 选中端口 聚合端口

提示：可按住左键拖拽选取多个端口。

注意：一个环网只需配置一个阻塞端口！

吉贝尔网。

添加阻塞 阻塞

(ERPS)

ERPS



ERPS

```
Switch1#show erps
ERPS Information
Global Status
Link monitored by
```

```
Switch3#sho erps
ERPS Information
Global Status      : Enabled
Link monitored by  : Not Oam
```

```
erps raps-vlan 4001
ERPS Information
Global Status      : Enabled
Link monitored by  : Not Oam
```

```
-----
R-APS VLAN
Ring Status
West Port
East Port
RPL Port
Protected VLANs
RPL Owner
Holdoff Time
Guard Time
WTR Time
Current Ring State
```

```
-----
R-APS VLAN      : 4001
Ring Status     : Enabled
West Port       : Gi0/17 (Forwarding)
East Port       : Gi0/18 (Blocking)
RPL Port        : East Port
Protected VLANs : ALL
RPL Owner       : Enabled
Holdoff Time    : 0 milliseconds
Guard Time     : 500 milliseconds
WTR Time       : 5 minutes
Current Ring State : idle
```

```
-----
R-APS VLAN      : 4001
Ring Status     : Enabled
West Port       : Gi0/2 (Forwarding)
East Port       : Gi0/9 (Forwarding)
RPL Port        : None
Protected VLANs : ALL
RPL Owner       : Disabled
Holdoff Time    : 0 milliseconds
Guard Time     : 500 milliseconds
WTR Time       : 2 minutes
Current Ring State : idle
```

(ERPS)

ERPS



```
1 shutdown erps
2 erps ERPS trunk
3 ERPS R-APS VLAN R-APS VLAN
4 ERPS RPL Owner Owner ERPS
  protection
5 ERPS ERPS
6 shutdown erps
7 ERPS ERPS RLDP RLDP
shutdown
```

Contents

SmartWeb

ERPS

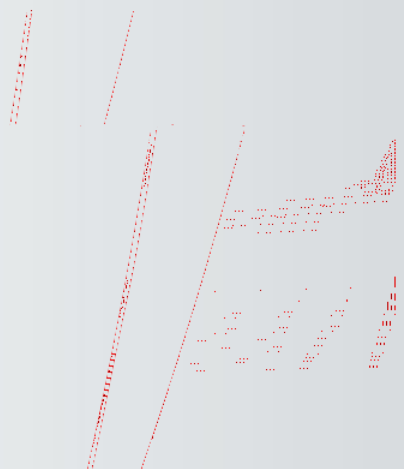
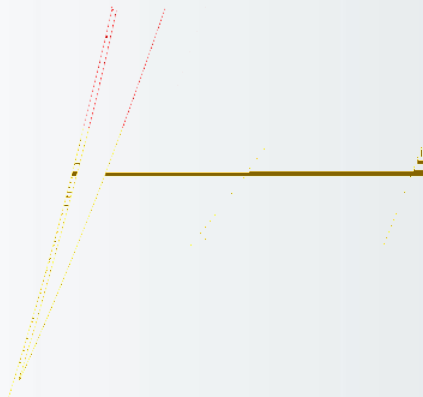

| SmartWeb

SmartWeb

IS2700G

SmartWeb

CLI

/ VLAN / /

SNMP

SmartWeb

SmartWeb —



- 1 PC IP 192.168.1.0/24 PC IS2700G
gi0/1
- 2 PC <http://192.168.1.200> SmartWeb
admin/admin
- 3 SmartWeb
- 4

SmartWeb -----

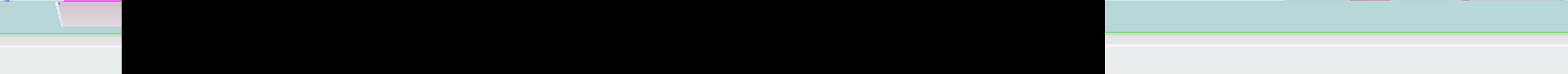
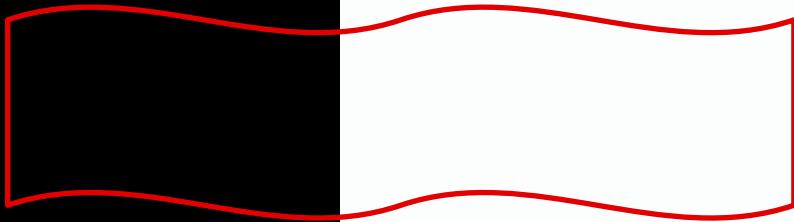
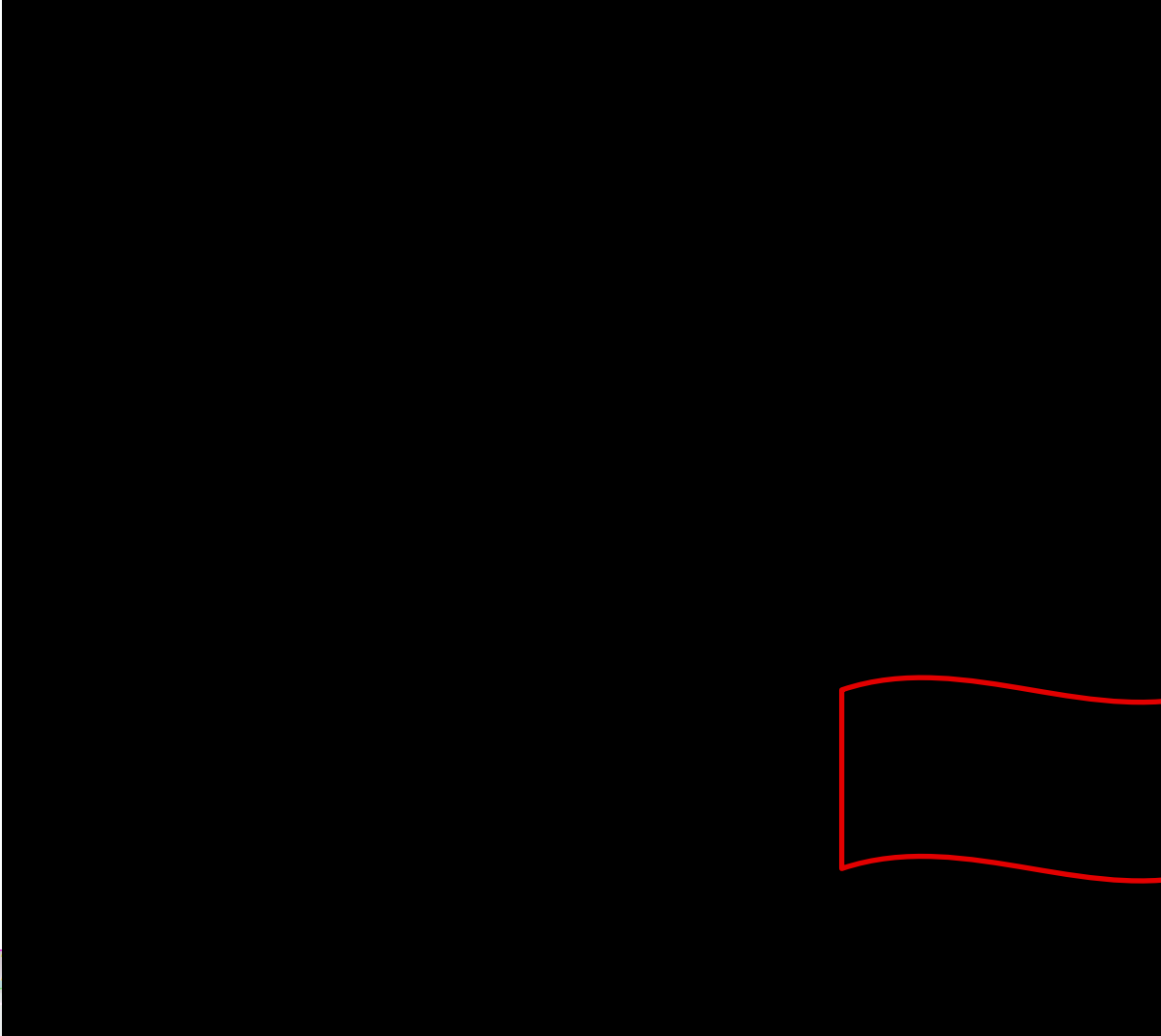

SmartWeb -----

SmartWeb

CPU/

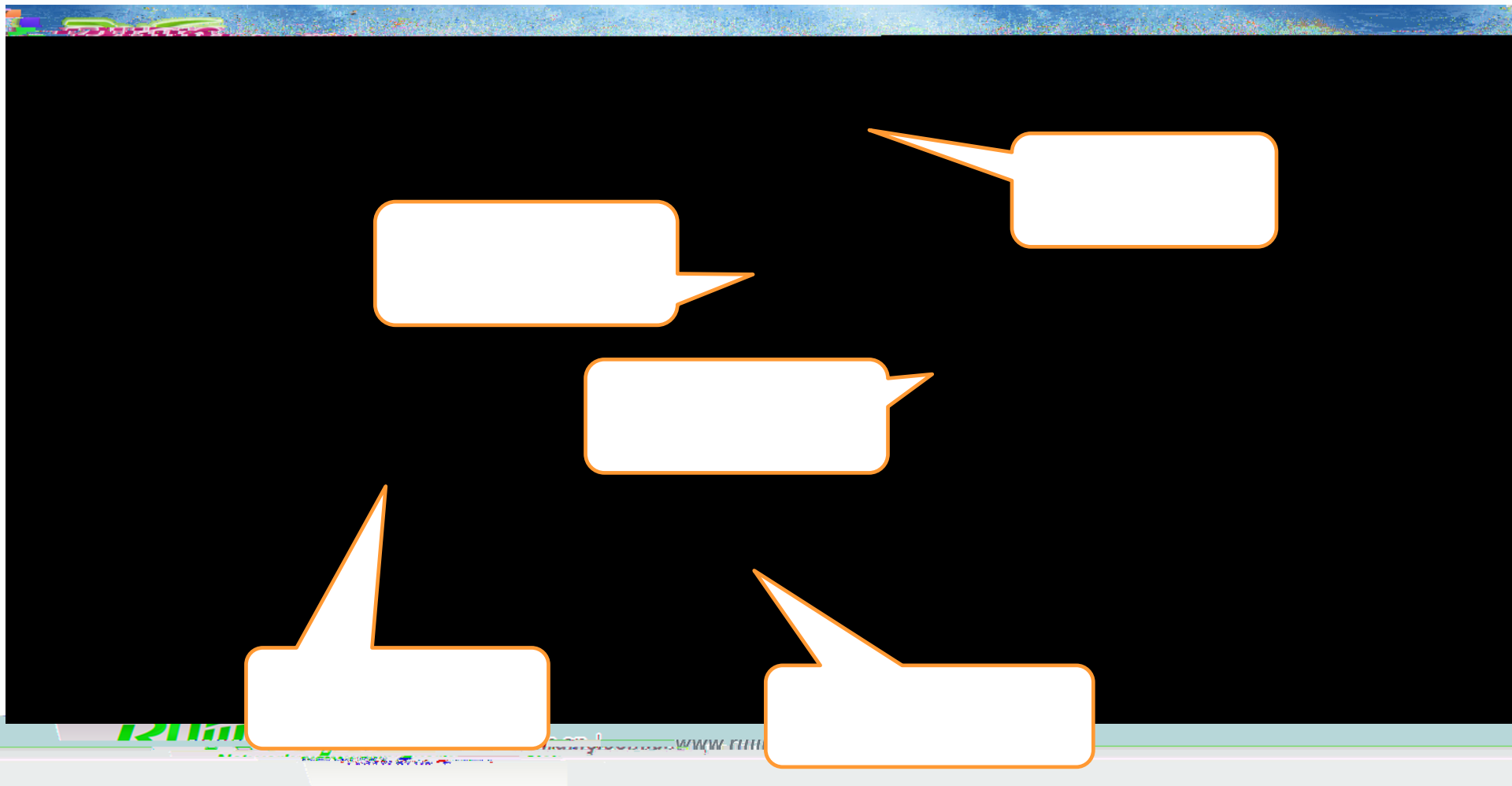

| SmartWeb -----

admin

guest



- www.ruijie.com.cn

- www.ruijie.com.cn/service.aspx

-