



AP AP850(DA)





802.11ax

2.4G / 5G

MU-MIMO

TWT

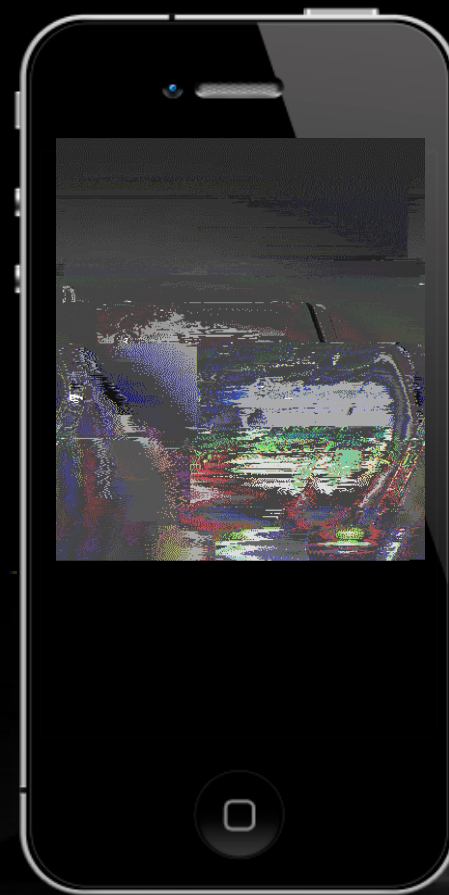

802.11ax



802.11ax

BSS-COLOR

CCA

MU-MIMO

OFDMA

9.6Gbps

1201Mbps

600Mbps

802.11ac

4

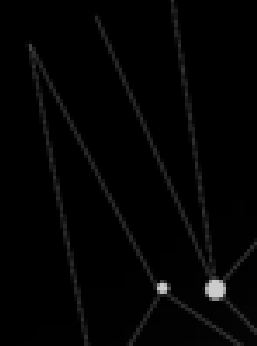

RG-AP850(DA)



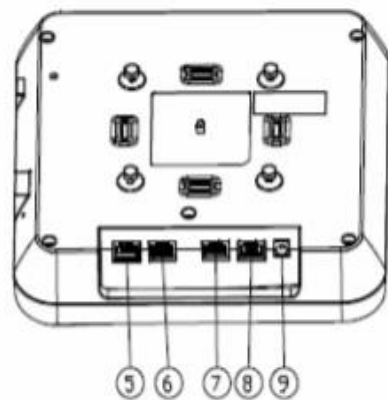
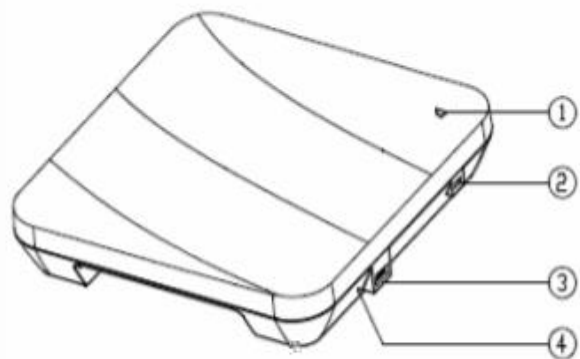

注释:

- ① 指示灯
- ② 笔记本电脑锁
- ③ USB 接口
- ④ Reset 按键
- ⑤ Console 口
- ⑥ LAN3/IOT 网口
- ⑦ LAN2/PoE 网口
- ⑧ LAN1/PoE 网口
- ⑨ 48V 直流适配器输入口

—		AP	/	
3Hz			AP	uboot
—			AP	
3Hz		AP		Link down
—		AP		CAPWAP
3Hz		AP		
—		AP		CAPWAP
3Hz		AP		CAPWAP
3Hz	2		AP	AP
				2S

AP850(DA)

—	AP /	
3Hz	AP	uboot
—	AP	
3Hz	AP	Link down
—	AP	
3Hz	AP	
		2S
		3S

北京 -

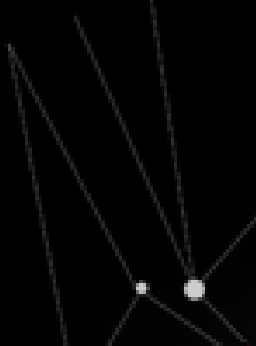

AP850(DA)

LAN

ap-config

ap-interface wireport 1 port-group 1

ap-interface wireport 2 port-group 1

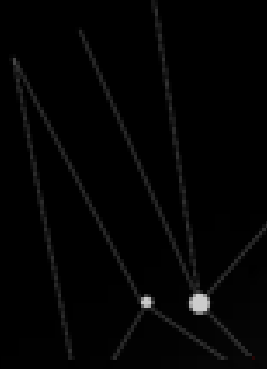

AP850(DA)

11AX

AP

11ax

11ax

STA

AP

11ax

AP

11

AP850(DA)

11AX

	mu

AP

MU MIMO

802.11AC

802.11AX

STA



智慧校园



智能家居



智能

AP850(DA)

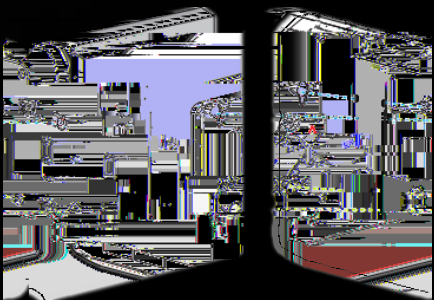
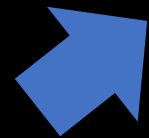



THANKS